

*Roco*

# Neuheitenkatalog 2016

## New Products 2016

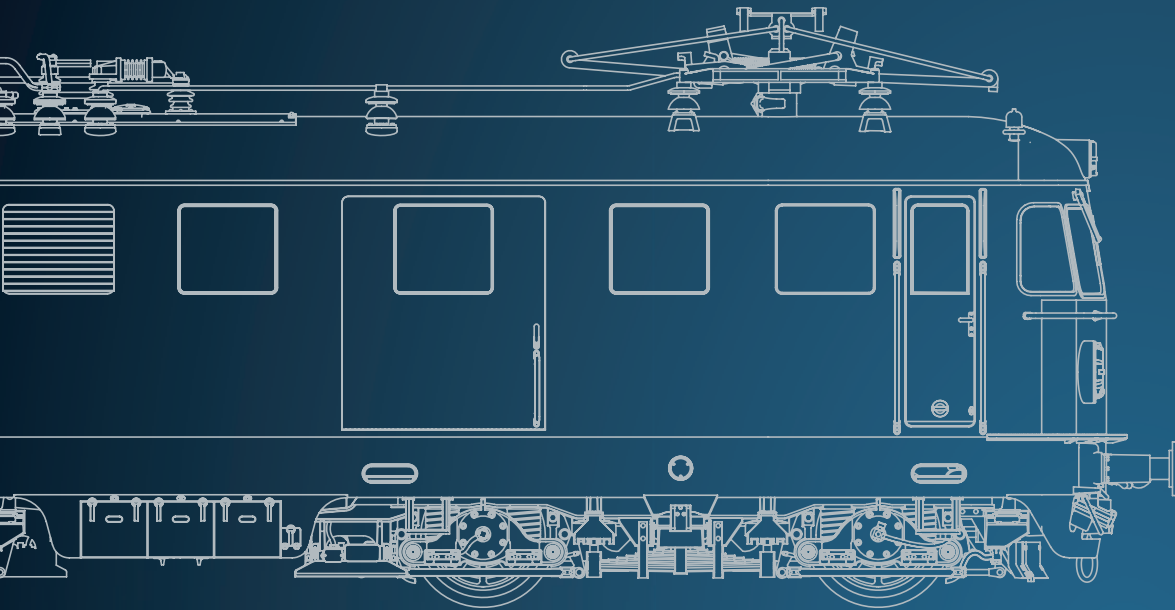



## Liebe Modellbahnfreunde,

mit unserem Neuheitenkatalog 2016 halten Sie unsere Entwicklungen für das Modellprogramm 2016 in Händen!

Angefangen bei unserer Neukonstruktion, der schweren Dampflokomotive der Baureihe 85 bis hin zur Diesellokomotive der Baureihe 210, welche mit ihrem Gasturbinenantrieb schon als Vorbild zu begeistern wusste. Mit der Schweizer Elektrolokomotive der Reihe 460 steht nun ein weiteres Modell mit eingebauter Kamera für noch mehr Spielspaß zur Verfügung. Doch auch die österreichischen Modelleisenbahner erhalten mit der E-Lok Reihe 4061 ein fein detailliertes und zeitgemäßes Modell.

In großer Stückzahl wurden beim Vorbild die Güterwagen der Bauarten Linz und Villach abgeliefert und auch unsere Modelle überzeugen im kleinen Maßstab mit vielen extra angesetzten Details.

Im Digitalbereich stellen wir mit unserer WLAN multiMaus ein zeitgemäßes Handsteuergerät vor, das in Kombination mit unserer innovativen und beliebten Z21 Modellbahnsteuerung noch mehr Möglichkeiten bei der Bedienung und Steuerung eröffnet.

Doch das ist noch nicht alles! Viele weitere Neuheiten und Formvarianten werden Sie auf den nachfolgenden 100 Seiten begeistern.

Neu ist auch die Klassifizierung der Produkte. Für all jene, die gerade mit dem schönsten Hobby der Welt beginnen möchten, ist unser Einsteigerprogramm mit dem Namen „Start“ genau das Richtige. Unser preisbewusstes Einsteiger-Programm finden Sie übrigens in einem separaten Katalog bei Ihrem Fachhändler.

Das breit gefächerte Standardsortiment umfasst alles, was der Bahnbetrieb auf der heimischen Modellbahn braucht. Neu führen wir in diesem Jahr unsere Produktlinie mit dem Namen „Edition“ ein. All jene Produkte, welche über diese Kennzeichnung verfügen, zeichnen sich durch besondere technische Raffinessen und Digital-Funktionen im Maßstab 1:87 aus.

Doch nun genug der Worte, Bühne frei für die Roco Neuheiten 2016.

Ihr Roco Modellbahn Team

## Dear Model Railway Enthusiasts,

We are proud to present our new model railway range 2016 in this New Products Catalogue 2016!

Starting from our latest design, the heavy steam locomotive of the 85 series, to the diesel locomotive of the 210 series where the original caused quite a stir with its gas turbine drive. With the Swiss electric locomotive of the 460 series another model with integrated camera for even more fun has been added to the range. There is also a finely detailed and modern model available for Austrian model railway enthusiasts: the electric locomotive series 4061.

The original freight car models „Linz“ and „Villach“ were supplied in large numbers, and our models are outstanding with all their many great small scale extra details. In the digital field we introduce our WLAN MultiMouse: a modern control device that opens up even more control options in combination with our innovative and popular Z21 model railway control unit.

And that's by no means all – we have much more in store for you! Enjoy the following

100 pages filled to the brim with novel products and variants.

We have also changed the classification of our products. For those of you who are only beginning to enjoy the world's most fascinating hobby, we offer our beginners a special range entitled „Start“. Ask your specialist dealer for our separate catalogue dedicated to our bargain beginners range.

The wide standard range includes everything you may need for your model railway system. New this year is our „Edition“ product line. All products of this range boast particular technical refinement and digital features in a 1:87 scale.

Enough has been said – so clear the line ahead now for the New Roco Products 2016!

Yours,  
the Roco Modellbahn team

## INHALT / TABLE OF CONTENT

	Qualität und Service / Quality and Service .....	4		
H0	Dampflokomotiven / Steam locomotives .....	6	H0	Güterwagen / Goods wagons .....
H0	Elektrolokomotiven / Electric locomotives .....	16	H0e	H0e .....
H0	Diesellokomotiven / Diesel locomotives .....	43		Digitaltechnik / Digital Technique .....
H0	Personenwagen / Passenger vehicles .....	62		Was finde ich wo / Where do I find what.....
				Impressum / Imprint.....
				72
				96
				100
				104
				106

# Die Leidenschaft zur Modelleisenbahn.

Mit unseren Modellen setzen wir Maßstäbe in den Spurweiten H0, H0e und TT. Unsere Leidenschaft zur Modellbahn soll in jedem unserer Produkte zu spüren sein. Deshalb schreiben wir SERVICE groß und sind bemüht unseren Kunden immer zur Seite zu stehen.

## Passion for model railways

Our models set the standard for H0, H0e and TT track gauges. We want our passion for model railways to be tangible in every one of our products. This is why service is of the essence to us; we take every effort to assist our customers.

## Check the Points

- ✓ 650 Neuheiten pro Jahr / 650 new products per year
- ✓ 1.400 Modelle verfügbar / 1400 available models
- ✓ 30.000 Ersatzteile auf Lager / 30,000 spare parts in stock
- ✓ Lange Ersatzteilverfügbarkeit  
Spare parts available for a long time
- ✓ Qualitätsfertigung von Hand  
Quality production by hand
- ✓ Bis zu 400 Einzelteile pro Modell  
Up to 400 individual parts per model
- ✓ Hotline (Telefon & E-Mail), Info: [www.roco.cc](http://www.roco.cc)  
Hotline (telephone and email), info: [www.roco.cc](http://www.roco.cc)
- ✓ Newsletter gratis, [www.roco.cc](http://www.roco.cc)  
Free newsletter, [www.roco.cc](http://www.roco.cc)



Beschriftung wie beim Original / Labelling identical to the original



Entwicklung nach Originalunterlagen  
Development of designs using original documentation



30.000 Ersatzteile auf Lager / 30,000 spare parts in stock

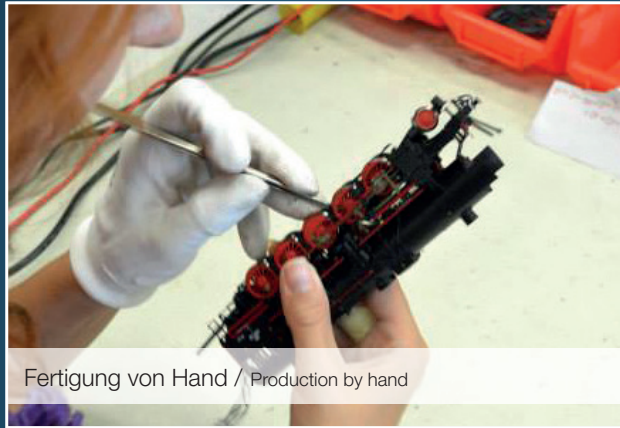

Fertigung von Hand / Production by hand



Genaueres Maßnehmen am Original  
Careful measuring of the original

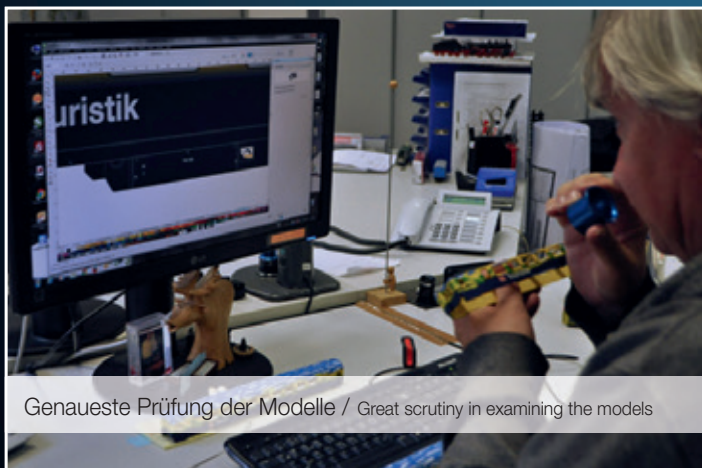

Genaueste Prüfung der Modelle / Great scrutiny in examining the models



Experten für Technik und Modellbau  
Experts in model construction and technology

**Roco**  
Edition

**IHO** Dampflokomotiven / Steam locomotives

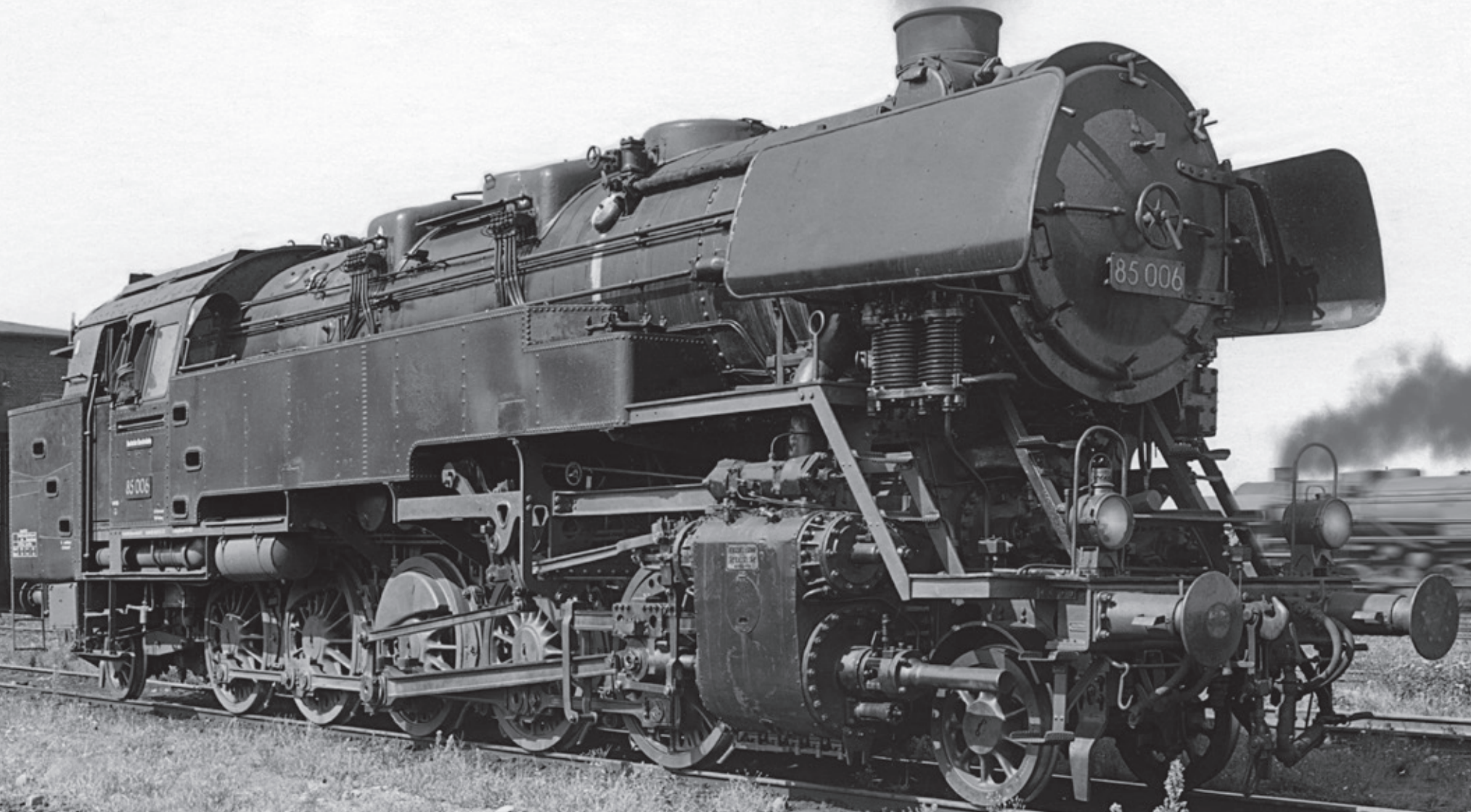

## Dampflokomotive 85 007, DB / Steam locomotive 85 007, DB



Sound



Ep III

187

PluX22

2017



K. Ganfer / Slg. Wolny

dynamischer Dampf  
dynamic smokeNeukonstruktion  
New Design

Abb. zeigt 85 009\* / Illustration depicts 85 009\*

## Info

Fein detailliert ausgeführtes Modell mit vielen separat angesetzten Steckteilen. Motor mit Schwungmasse, feine Metallradsätze mit niedrigen Spurkränzen. LED-Spitzenlicht mit der Fahrtrichtung wechselnd. Im Digitalbetrieb (72271) mit dynamischem Dampf und umfangreichen Soundfunktionen.

A model displaying lots of fine detail with many separately applied add-ons. Engine with flywheel mass, finely-made sets of metal wheels with a low wheel flange. LED-lighting which change when there is a change in direction. Digital operation (72271), with dynamic steam and sound.

Art. Nr.: 72270



€ 369,00

Art. Nr.: 72271



€ 499,00

Art. Nr.: 78270



€ 409,00

Art. Nr.: 78271



€ 499,00

Mit der Dampflokomotive der Baureihe 85 rollt Anfang 2017 ein echtes Schwergewicht zu den Modelleisenbahnern. Insgesamt wurden nur 10 Lokomotiven der rund 133 Tonnen schweren Tenderlokomotive für den Einsatz auf der so genannten Höllentalbahn gebaut. Auf Basis der Dampflokomotiven der Baureihen 44 und 62 konnte Henschel am 13. Dezember 1932 mit 85 001 die erste Höllental-Lokomotive abliefern. Die 10 Lokomotiven bewährten sich während ihrer vielen Dienstjahre hervorragend durch ihre Traktionseigenschaften und beim Lokomotivpersonal. So konnte bereits zum Fahrplanwechsel 1933 die Zahnstange, die für den bisherigen Betrieb auf der Strecke notwendig war, demontiert werden. Die Fahrzeiten konnten dank der gelungenen Konstruktion der 85er auf der Strecke von Freiburg im Breisgau nach Neustadt von 120 auf nunmehr 90 Minuten reduziert werden. Das Ende für die Dampflokomotiven der Baureihe 85 kam mit der Umstellung auf die Stromversorgung mit 15 Kv/16 2/3 Hz, womit ab diesem Zeitpunkt alle Elektrolokomotiven aus dem Betriebsbestand der DB auf der Strecke zum Einsatz kommen konnten. Nur ein Exemplar, nämlich 85 007, wurde nach ihrer Karriere auf der Höllentalbahn noch auf der Steilrampe Erkrath-Hochdahl eingesetzt. Heute ist nur mehr diese Lokomotive museal erhalten und soll bei der IG 3-Seenbahn e.V. eine betriebsfähige Aufarbeitung erhalten.

The class 85 steam locomotive which will appear at the beginning of 2017 will be a real heavyweight for model train enthusiasts to look forward to. In total only 10 units of this 133-ton tank locomotive were built for use on the so-called Hell's Valley rail line (Höllentalbahn). Based on the class 44 and class 62 steam locos, Henschel delivered the first unit, numbered 85 001 on 13 December 1932. The 10 locomotives proved their worth admirably throughout their many years of service through their excellent traction capability and they were popular with the people working on them. When the new timetable was issued in 1933, it was already possible to dismantle the rack that had been required for operations on that stretch of track. Thanks to the 85's successful design, journey times on the stretch from Freiburg im Breisgau to Neustadt were reduced from 120 minutes to just 90 minutes. The end of the line for the series 85 steam engines came with the line's conversion to 15 Kv/16 2/3 Hz electricity supply, at which point the electric locomotives of the DB could be used on the line. Only one model – the 85 007 – was deployed after its withdrawal from the Höllental line, namely on the Erkrath-Hochdahl ascent. Today this locomotive preserved in a museum, is being restored to an operational level by the IG 3-Seenbahn e.V. group of enthusiasts.

## Dampflokomotive S 160, USATC "US. Zone Österreich" / Steam locomotive S 160, USATC „US Zone Austria“

Neukonstruktion  
New Design

Sound

  
**USTC**  
 Ep III  
 211  
 PluX16



Art. Nr.: 72152 = € 369,00

Art. Nr.: 72153 = € 444,00

Art. Nr.: 78153 ~ € 444,00

Komplette Neukonstruktion der auch unter dem Namen „Klapperschlange“ bekannten Kriegslokomotive. Fein detailliert ausgeführtes Modell mit vielen separat angesetzten Steckteilen. Motor mit Schwungmasse, LED-Spitzenlicht, feine Radsätze mit niedrigen Spurkränzen.

■ Einsatz vor Güterzügen

Completely new design of the war locomotive that was also well known under the nickname "Klapperschlange" "Rattlesnake". Rich detailing on the model with many separately applied plug-in parts. Engine with mass flywheel, LED lighting, elaborately designed wheel sets with low flanges.

■ Used in front of freight trains

## Dampflokomotive 52 3315, ÖBB / Steam locomotive 52 3315, ÖBB

Sound

Info

Alle unsere Lokomotiv- sowie Wagenmodelle verfügen über eine Kuppelungsaufnahme nach NEM 362, außer anders angegeben.

All our model locomotives and rolling stock are equipped with NEM 362 coupler pockets according to NEM standards, unless otherwise noted.

  
  
 Ep III  
 265  
 PluX16



Art. Nr.: 72222	=	€ 279,00
Art. Nr.: 72223	=	€ 354,00
Art. Nr.: 78223	~	€ 354,00

Motor mit Schwungmasse, Antrieb auf sieben Achsen. Eine Achse mit Haftreifen, LED-Spitzenlicht mit der Fahrtrichtung wechselnd.

■ Art. Nr. 72223 und 78223 mit digital schaltbaren Soundfunktionen. ■ Ausführung mit Giesl-Ejektor und Kabinentender.

Motor with flywheel. Traction tyres. Drive on seven axles (tender drive). LED-lighting that change with the direction of travel. With elaborately designed spoked metal wheels and driving/coupling rods that are made of the finest metal die cast.

■ Item Nr. 72223 and 78223 with digitally switchable sound functions. ■ Version with Giesl-ejektor and cab tender.



Dampflokomotive 688 01, ÖBB / Steam locomotive 688 01, ÖBB



Ep III

80



Art. Nr.: 72259 € 199,00



Modell mit eingebautem Digital-Sounddecoder, Motor mit Schwungmasse. Antrieb auf zwei Achsen.

- Ein passendes 2-teiliges Wagenset mit Abraummaterial finden Sie auf Seite 75, Art.Nr. 67196.

Model with built-in digital decoder and digitally switchable sound functions. 5-pole motor. Drive on two axles.

- A matching 2 piece wagon set with load can be found on page 75, Item No. 67196.

Dampflokomotive Reihe 365.4, CSD / Steam locomotive class 365.4, CSD



CSD

Ep III

143

NEM 652



Art. Nr.: 73202 € 199,00     Art. Nr.: 73203 € 274,00



Motor mit Schwungmasse, Antrieb auf drei Achsen, zwei Haftreifen. LED-Spitzenlicht mit der Fahrtrichtung wechselnd. Vorbereitet für die Aufnahme eines Seuthe Rauchentwicklers.

- Ausführung mit großem Stern
- Art. Nr. 73203 mit digital schaltbaren Soundfunktionen.

Motor with flywheel. Drive on three axles, two traction tyres. LED-lighting that changes with the direction of travel. Ready equipped to install a Seuthe smoke generator.

- Model with big star
- Item Nr. 73203 with digitally switchable sound functions.

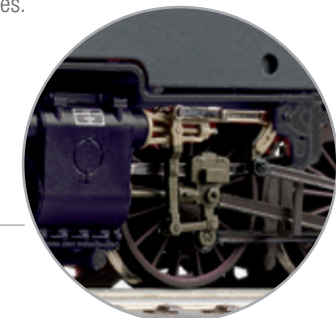

## Dampflokomotive BR 44 Kohle, DB / Steam locomotive class 44 coal, DB



Ep III

260

NEM 652



Art. Nr.: 72234	=	€ 279,00
Art. Nr.: 72235	=	€ 369,00
Art. Nr.: 78235	~	€ 369,00

Modell mit Metallradsätzen, Motor mit Schwungmasse. Antrieb auf sieben Achsen, zwei Achsen mit Haftreifen.

- Einsatz vor schweren Güterzügen

Model with metall wheel sets, motor with flywheel. Drive on seven axles. Traction tyres to increase traction power.

- Used in front of heavy freight trains

## Dampflokomotive BR 44 Öl, DR / Locomotive class 44 oil, DR



DR

Ep III

260

NEM 652



Art. Nr.: 72232	=	€ 279,00
Art. Nr.: 72233	=	€ 369,00

Ausführung mit Öltender. Modell mit Metallradsätzen, Motor mit Schwungmasse. Antrieb auf sieben Achsen, zwei Achsen mit Haftreifen. Dreilicht-Spitzensignal mit Fahrrichtung wechselnd.

- Einsatz vor schweren Güterzügen

Version with oil tender. Model with metall wheel sets and motor with flywheel. Drive on seven axles. Traction tyres to increase traction power. Triple headlights that change with the direction of travel.

- Used in front of heavy freight trains

Dampflokomotive 44 9116 Kohlestaub, DR / Steam locomotive 44 9116 coal dust, DR



Ep IV

260

NEM 652



Art. Nr.: 72230	=	€ 279,00
Art. Nr.: 72231	=	€ 369,00
Art. Nr.: 78231	~	€ 369,00

Ausführung als Kohlestaublokomotive. Modell mit Metallradsätzen, Motor mit Schwungmasse. Antrieb auf sieben Achsen, zwei Achsen mit Haftreifen.

- Einsatz vor schweren Güterzügen

Version as coal dust locomotive. Rich detailing on the model that features metal wheels, a motor with flywheel. Drive on seven axles (tender drive). Traction tyres to increase the traction power.

- Used in front of heavy freight trains.



Henning Sound

Alle Lokomotiven mit dem Hinweis „Henning Sound“ verfügen über besonders aufwendige und umfangreiche Soundgeräusche der Henning Soundmanufaktur. Lassen Sie sich überraschen von einem völlig neuen Sounderlebnis!

Weitere Informationen dazu finden Sie auf unserer Homepage [www.roco.cc](http://www.roco.cc)

All engines marked „Henning Sound“ feature the particularly sophisticated and comprehensive range of sounds from Henning Sound. Let yourself be carried away by a completely new sound experience!

For additional information simply visit our homepage [www.roco.cc](http://www.roco.cc)

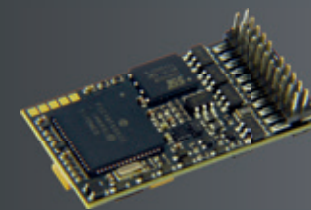

by



Roco fährt ZIMO. Der Sound-Decoder MX645P22 ist das am häufigsten verbaute Modell. Er zeichnet sich durch die einzigartige ZIMO Motorregelung, 10 Funktionsausgänge, und einem starkem Sound für bis zu zwei Lautsprecher aus.

„Roco runs A to Z with ZIMO. The MX645P22 sound decoder is the most frequently installed model. The outstanding features include the unique ZIMO motor management, 10 function outputs plus powerful sound for up to two loudspeakers.“





Dampflokomotive 50 2487, DB / Steam locomotive 50 2487, DB



  
  
 Ep III  
 260  
 PluX16





Art. Nr.: 72174	=	€ 279,00
Art. Nr.: 72175	= 	€ 354,00
Art. Nr.: 78175	~ 	€ 354,00

Antrieb auf sieben Achsen, zwei Achsen mit Haftreifen. LED-Spitzenlicht mit Fahrtrichtung wechselnd. Rauchgenerator nachrüstbar. Mit Wagner Windleitblechen und Kabinentender.  
 Drive on seven axles (locomotive tender drive), two of them have traction tyres. LED-lighting that change with the direction of travel. Smoke generator can be retrofitted. The model features smoke deflectors and a cab tender.

Dampflokomotive BR 064, DB / Steam locomotive class 064, DB



  
  
 Ep IV  
 143  
 NEM 652

Antrieb auf drei Achsen, zwei Haftreifen, Motor mit Schwungradmasse. LED-Spitzenlicht mit der Fahrtrichtung wechselnd.  
 ■ Nachbildung der Version mit geschweißten Wasserkästen.  
 ■ Art. Nr. 62198, 68199 mit digital schaltbaren Soundfunktionen.  
 Drive on three axes. Two traction tyres. Motor with flywheel. LED-lighting that change with the direction of travel.  
 ■ Replica of the version with welded water tanks.  
 ■ Item Nr. 62198, 68199 with digitally switchable sound functions.



Art. Nr.: 62197	=	€ 199,00	Art. Nr.: 62198	= 	€ 274,00	Art. Nr.: 68198	~ 	€ 274,00
-----------------	---	----------	-----------------	---	----------	-----------------	---	----------

Dampflokomotive 50 1002, DR / Steam locomotive 50 1002, DR



Ep IV

260

PluX16



Handmuster / handmade model

Art. Nr.: 72176 € 279,00      Art. Nr.: 72177 € 354,00

Antrieb auf sieben Achsen, zwei Achsen mit Haftreifen. LED-Spitzenlicht mit der Fahrtrichtung wechselnd.

- Mit vorbildgerechten Wagner-Windleitblechen in Ätztechnik.

Drive on seven axles (locomotive tender drive), two of them have traction tyres. LED-lighting that change with the direction of travel.

- With true to the original Wagner smoke deflectors partially etched.

Dampflokomotive BR 52 Reko, DR / Steam locomotive class 52 Reko, DR



Ep IV

265

PluX16



Art. Nr.: 72224 € 279,00      Art. Nr.: 72225 € 354,00

Motor mit Schwungmasse, zwei Achsen mit Haftreifen. LED-Spitzenlicht mit der Fahrtrichtung wechselnd.

- Die Lokomotiven der BR 52 Reko wurden auf Haupt- und Nebenbahnen vor Güter- und Personenzügen eingesetzt.

Motor with flywheel. Traction tyres. LED-lighting that change with the direction of travel.

- The locomotives of the series 52 Reko pulled goods and passenger trains on main and branch lines.

Dampflokomotive 001 180-9, BEM / Steam locomotive 01 180-9, BEM



PRIVAT

Ep VI

275

NEM 652



Art. Nr.: 72194	=	€ 279,00
Art. Nr.: 72195	=	€ 354,00
Art. Nr.: 78195	~	€ 354,00

Motor mit Schwungmasse, Antrieb auf vier Tenderachsen sowie alle Treibachsen, zwei Achsen mit Haftreifen. Dreilicht-Spitzensignal mit der Fahrtrichtung wechselnd.

- Im Zustand als betriebsfähige Museumslokomotive.

Motor with flywheel, drive on four tender axles as well as on all driven axles, two traction tyres. Triple headlights that change with the direction of travel.

- Operates like a fully operational museum locomotive.

Dampflokomotive 150X35, SNCF / Steam locomotive 150X35, SNCF



Ep III

260

NEM 652

Motor mit Schwungmasse. Zweilicht-Spitzensignal. Antrieb auf sieben Achsen, zwei Achsen mit Haftreifen.

- Ausführung mit großen Windleitblechen.

Motor with flywheel. Double headlight. Drive on seven axles. Two traction tyres.

- Version with smoke deflectors.

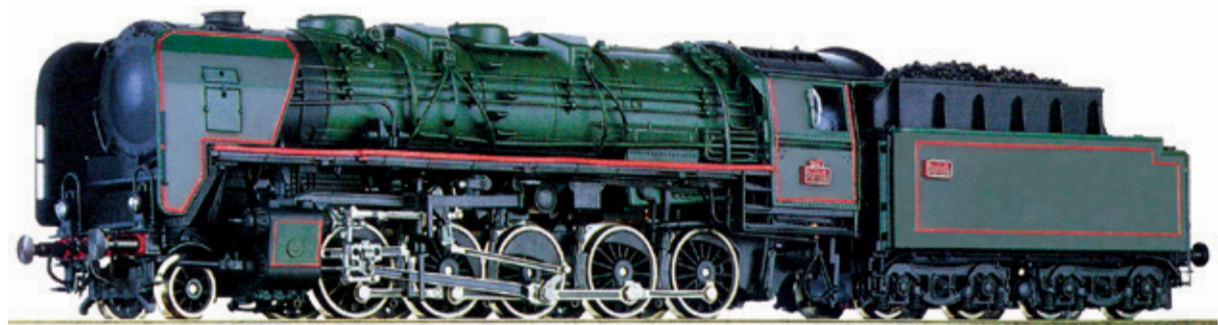

Art. Nr.: 62148 = € 279,00

Art. Nr.: 62149 = € 354,00

Art. Nr.: 68149 ~ € 354,00

Dampflokomotive Gruppo 736, FS / Steam locomotive Gruppo 736, FS



Ep III

211

PluX16



Hans J. Rosenberger

**Neukonstruktion  
New Design**

**Sound**



**CAD Grafik**  
Zeigt die markante italienische Front der Gruppo 736

**CAD Illustration**  
Shows the eye-catching italian locomotive nose of the Gruppo 736

Komplette Neukonstruktion der auch unter dem Namen „Klapperschlange“ bekannten Kriegslokomotive. Fein detailliert ausgeführtes Modell mit vielen separat angesetzten Steckteilen. Motor mit Schwungmasse, LED-Spitzenlicht, feine Radsätze mit niedrigen Spurkränzen.

- Einsatz vorwiegend im Güterverkehr

Completely new design of the war locomotive that was also well known in Europe under the nickname "Klapperschlange" "Rattlesnake". Rich detailing on the model with many separately applied plug-in parts. Engine with mass flywheel, LED-lighting, elaborately designed wheel sets with low flanges.

- Used prevalent in freight traffic

Art. Nr.: 72158    € 369,00    Art. Nr.: 72159    € 444,00    Art. Nr.: 78159    € 444,00

Dampflokomotive S 160, USATC / Steam locomotive S 160, USATC



USATC

Ep II-III

211

PluX16

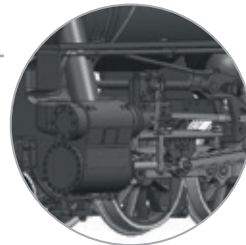

**CAD Grafik**  
**CAD Illustration**

Komplette Neukonstruktion der auch unter dem Namen „Klapperschlange“ bekannten Kriegslokomotive. Fein detailliert ausgeführtes Modell mit vielen separat angesetzten Steckteilen. Motor mit Schwungmasse, LED-Spitzenlicht mit der Fahrtrichtung wechselnd, feine Radsätze mit niedrigen Spurkränzen.

Completely new design of the war locomotive that was also well known under the nickname "Klapperschlange" "Rattlesnake". Rich detailing on the model with many separately applied plug-in parts. Engine with mass flywheel, LED-lighting that changes with the direction of travel, elaborately designed wheel sets with low flanges.

**Sound**

**Neukonstruktion  
New Design**



H. Nave

Art. Nr.: 72150    € 369,00    Art. Nr.: 72151    € 444,00    Art. Nr.: 78151    € 444,00



A. Schmid

Um der steigenden Nachfrage im Städtesschnellverkehr und den damit verbundenen Kapazitätsengpässen entgegen zu wirken, bestellten die Österreichischen Bundesbahnen bei den Wiener Lokomotivfabriken sowie der Firmengemeinschaft ABES (Verbund der Firmen AEG, Elin und Siemens-Schuckert Wien) die Gepäcktriebwagen der Reihe 4061. In zwei Bauserien wurden insgesamt 25 Stück der Triebwagen bestellt. Da sich das Gepäckabteil im Alltagsbetrieb nicht als betriebstauglich herausstellte, wurde im 4061 selten Gepäck transportiert. Dies war mit ein Grund, dass sich die ÖBB entschieden haben, den bisherigen „Triebwagen“ als Elektrolokomotive zu klassifizieren. Damit einher galt ab dem 30. Mai 1976 die neue Reihenbezeichnung 1046. Ende der 1980er Jahre wurde die Reihe 1046 aufgrund des immer schlechter werdenden Zustands grundlegend umgebaut. Dabei wurde der Lokkasten komplett neu aufgebaut. Dieser Umbau erfolgte bei insgesamt 13 Lokomotiven. Die übrigen 1046, welche nicht umgebaut wurden, fuhren 1993 auf die Abstellgleise bzw. wurden als Vorheizanlage verwendet. Die umgebauten Lokomotiven wurden im Jahre 2003 abgestellt. Einige 4061 bzw. 1046 sind heute in Österreich zum Teil noch betriebsfähig erhalten.

To meet the increasing demand for rapid city transit and to counteract the resulting capacity bottlenecks, Austrian Federal Railways placed an order for the 4061 baggage railcars at the Wiener Lokomotivfabriken and the ABES (a network of AEG, Elin and Siemens-Schuckert Wien). 25 railcars of this type were ordered in two batches. The baggage compartment turned out to be inconvenient and not user friendly, so that hardly any luggage was transported in the 4061. This was one of the reasons why the ÖBB decided to classify the former „railcar“ as an electric locomotive. This included a new designation for the class that became effective on 30 May 1976: 1046. As its condition deteriorated, the 1046 series underwent a major overhaul at the end of the 1980s. The car body was completely redesigned. A total number of 13 locomotives were converted. The remaining 1046 locomotives that had not been redesigned were moved to the siding in 1993 and were used as pre-heating units. The converted locomotives were taken out of service in 2003. Some 4061 and/or 1046 models were kept in operational condition in Austria.



### Elektrotriebwagen Rh 4061 der ÖBB / Electric railcar class 4061, ÖBB



Ep III-IV

186

PluX22

Nachbildung der 2. Serie in tannengrüner Farbgebung mit Flügelrad und Metallziffern, erhabene Metallzierlinie, Modell mit LED-Spitzenlicht ohne Zugschlusslampe.

- Komplette Neukonstruktion
- 5-poliger Motor mit Schwungmasse
- Niedrige Spurkränze
- Feine Steckteile
- Vorbildgerechte Umsetzung der Schürzen, freier Blick durch den Gepäckraum
- In Digitalausführung: Führerstands- und Gepäckraumbeleuchtung

2nd series of the Austrian Federal Railways in green livery. The model is equipped with flywheel, metal numbers, raised decorative metal trim lines and LED-lighting. Without tail lamp.

- Completely new design
- Five-pole motor with flywheel
- Low wheel flanges
- Realisation of the frame parts, true to the original.
- Intricately designed plug-in parts, free view through the luggage room
- In digital version: lighting in the drivers cab and in the baggage compartment



Photo: A. Zronek

Art. Nr.: 73292	=	€ 229,00	Art. Nr.: 73293	=	€ 309,00
Art. Nr.: 79293	~	€ 309,00			

**Neukonstruktionen  
New Designs**

### Elektrolokomotive Rh 1046, ÖBB / Electric locomotive class 1046, ÖBB



Ep IV

186

PluX22



Photo: B. Pintarich

**Sound**

Nachbildung der 2.Serie in blutoranger Farbgebung mit „Pflatsch“; Modell mit LED-Spitzenlicht und Zugschlusslampe.

- Komplette Neukonstruktion
- 5-poliger Motor mit Schwungmasse
- Niedrige Spurkränze
- Feine Steckteile
- Vorbildgerechte Umsetzung der Schürzen, freier Blick durch den Gepäckraum
- In Digitalausführung: Führerstands- und Gepäckraumbeleuchtung

2nd series of the Austrian Federal Railways in blood orange livery with „Pflatsch“. The model is equipped with LED-lighting and rear end light.

- Completely new design
- Five-pole motor with flywheel
- Low wheel flanges
- Intricately designed plug-in parts
- Intricately designed plug-in parts, free view through the luggage room
- In digital version: lighting in the drivers cab and in the baggage compartment

Art. Nr.: 73290	=	€ 229,00	Art. Nr.: 73291	=	€ 309,00
			Art. Nr.: 79291	~	€ 309,00

Elektrolokomotive Rh 1110, ÖBB / Electric locomotive class 1110, ÖBB



Motor mit Schwungmasse. Antrieb auf sechs Achsen, zwei Achsen mit Haftreifen. LED-Spitzenlicht mit der Fahrtrichtung wechselnd.

Die 110 km/h schnellen Lokomotiven wurden ab 1956 für den Einsatz vor Schnellzügen bestellt, in den späteren Jahren wurden sie vorrangig im Güterverkehr eingesetzt.

- Mit drittem Spitzenlicht und flachen Einheitslampen

Motor with flywheel. Drive on six axles, two of them have traction tyres. LED-lighting (white/red).

The locomotives reached a maximum speed of 110 km/h and after having been ordered in 1956 they were first used for express trains and later on, mainly in front of trains for hauling freight.

- With third lighting and flat lamps



Ep III-IV

205

PluX22

Art. Nr.: 73222 € 199,00

Art. Nr.: 73223 € 274,00

Art. Nr.: 79223 € 274,00

Elektrolokomotive Rh 1042.5, ÖBB / Electric locomotive class 1042.5, ÖBB



Motor mit Schwungmasse. Antrieb auf vier Achsen, zwei Haftreifen. Dreilicht-Spitzenbeleuchtung weiß/rot mit der Fahrtrichtung wechselnd. Die 150 km/h schnelle Mehrzwecklokomotive wurde in ganz Österreich vor Schnellzügen, aber auch im Güterverkehr eingesetzt.

Motor with flywheel. Drive on four axles. Traction tyres. Red/white triple headlights that change with the direction of travel. The 150km / h fast general-purpose locomotive pulled express trains as well as freight trains throughout Austria.



Ep IV

186

NEM 652

Art. Nr.: 73472 € 189,00

Art. Nr.: 73473 € 264,00

Art. Nr.: 79473 € 264,00

Elektrolokomotive 1043 003, ÖBB / Electric locomotive 1043 003, ÖBB



Ep V

179

PluX22



Photo: Bernd Pinterich



Motor mit Schwungmasse. Antrieb auf vier Achsen, zwei Haftreifen. LED-Spitzenlicht weiß/rot mit der Fahrtrichtung wechselnd.

- Formänderungen dem Vorbild entsprechend umgesetzt.

Engine with mass flywheel. Drive on four axles, two traction tyres. Triple LED-lighting white/red changes with the direction of travel

- Modified tooling true to the original.

Art. Nr.: 73392 € 199,00

Art. Nr.: 73393 € 274,00

Art. Nr.: 79393 € 274,00

Elektrolokomotive Rh 1044, ÖBB / Electric locomotive class 1044, ÖBB



Ep IV

184

PluX22

Motor mit Schwungmasse, Antrieb auf vier Achsen, zwei Haftreifen. LED-Spitzenlicht weiß/rot mit der Fahrtrichtung wechselnd.

Die Lokomotive fuhr Anfang der 1990er Jahre mit Schnell- und Güterzügen bis nach Deutschland.

- Viele extra angesetzte Steckteile, teilweise in Ätztechnik.

Motor with flywheel, drive on four axles, one axle has traction tyres. LED-lighting white/red that changes with the direction of travel.

In the early 1990s the locomotive pulled express trains as well as freight trains to Germany.

- Many separately applied plug-in parts that are partially etched.



Art. Nr.: 73552 € 179,00

Art. Nr.: 73553 € 249,00

Art. Nr.: 79553 € 249,00

## Elektrolokomotive 1016 012, ÖBB / Electric locomotive class 1016 012, ÖBB



Ep VI

221

PluX22



Motor mit Schwungmasse. Antrieb auf vier Achsen, zwei Haftreifen. LED-Spitzenlicht weiß/rot mit im Digitalbetrieb schaltbarem Fernlicht und einzeln schaltbarem Spitzen- oder Schlusslicht.

- Ausführung mit langer UIC-Nummer.

Motor with flywheel. Drive on four axles, two of them have traction tyres. White/red triple LED-lighting with in digital mode switchable high beams. Also equipped with separately switchable headlights and taillight.

- Model with long UIC number.

Art. Nr.: 73230



€ 189,00

Art. Nr.: 73231



€ 259,00

Art. Nr.: 79231



€ 259,00

## Elektrolokomotive 1116 168 Vegatrans, ÖBB / Electric locomotive 1116 168 Vegatrans, ÖBB



Ep VI

221

PluX22



Aktuelle Ausführung im Werbedesign für das Transport- und Logistikunternehmen „Vega Trans“. Die Lokomotive symbolisiert die langjährige Partnerschaft der Firma Vega mit der Rail Cargo Group.

Motor mit Schwungmasse. LED-Spitzenlicht weiß/rot mit der Fahrtrichtung wechselnd. Antrieb auf vier Achsen, zwei Haftreifen, zwei Stromabnehmer.

Current operation condition with promotion design of the forwarding and logistics company „Vega Trans“. The locomotive symbolize the longstanding partnership between the company Vega and the Rail Cargo Group.

Motor with flywheel. LED-lighting white/red that change with the direction of travel. Drive on four axles, two of them have traction tyres, two pantographs.

Art. Nr.: 73235



€ 199,00

Art. Nr.: 73236



€ 269,00

Art. Nr.: 79236



€ 269,00



## Elektrolokomotive 1116 220 „Railjet“, ÖBB / Electric locomotive 1116 220 „Railjet“, ÖBB



Ep VI

221

PluX22

Motor mit Schwungmasse. Antrieb auf vier Achsen, zwei Haftreifen, drei Stromabnehmer. LED-Spitzenlicht weiß/rot mit im Digitalbetrieb schaltbarem Fernlicht und einzeln schaltbarem Spitzen- oder Schlusslicht.

- Art. Nr. 73233 und 79233: mit elektrisch leitenden Kupplungen.

Motor with flywheel. Drive on all four axles, two of them have traction tyres. Three pantographs. White/red triple LED-lighting with in digital mode switchable high beams. Also equipped with separately switchable headlights and tail light.

- Item Nr. 73233 and 79233: with electric coupling.



Art. Nr.: 73232 = € 199,00

Art. Nr.: 73233 = € 269,00

Art. Nr.: 79233 ~ € 269,00

## Elektrolokomotive 1116 202 „Railjet“ mit Kamera, ÖBB / Electric locomotive 1116 202 „Railjet“ with cam, ÖBB



Ep VI

221

PluX22



Motor mit Schwungmasse. Antrieb auf vier Achsen, zwei Haftreifen. Drei Stromabnehmer. LED-Spitzenlicht weiß/rot mit im Digitalbetrieb schaltbarem Fernlicht und einzeln schaltbarem Spitzen- oder Schlusslicht.

Ausgerüstet mit einer integrierten Kamera, deren Bild direkt über einen in der Lok eingebauten WLAN-Baustein auf ein WLAN-fähiges Endgerät (Smartphone, Tablet, PC, Fernseher) übertragen wird.

- Andere Betriebsnummer als 73232, 73233 und 79233.

Motor with flywheel. Drive on four axles, two of them have traction tyres. Three pantographs. White/red triple LED-lighting with in digital mode switchable high beams. Also equipped with separately switchable headlights and tail light. Digitally switchable sound functions.

The model is equipped with a built-in camera. The video image is directly transferred to a WIFI compatible device (Smartphone, Tablet, PC, TV).

- Different running number than 73232, 73233 and 79233.

Art. Nr.: 73234 = € 429,00

Art. Nr.: 79234 ~ € 429,00

RJ 162  21  
 Budapest Keleti pu.  
 Wien Hbf - Salzburg Hbf  
 Zürich HB

Set: 4tlg. Railjet RJ 162, ÖBB / 4 piece set Railjet RJ 162, ÖBB

- Mit neuen, kleinen Railjet Schriftzügen.
- With new Railjet branding.



Ep VI

1222

Art. Nr.: 64178	=	€ 279,00
Art. Nr.: 64179	= ⚡	€ 349,00
Art. Nr.: 64180	~ ⚡	€ 349,00

4-teiliges Wagenset „Railjet“ der Österreichischen Bundesbahnen.  
 Steuerwagen mit LED-Spitzenlicht und zwei roten Schlussleuchten.

- Die Art. Nr. 64179 und 64180 (AC) verfügen ab Werk über eine eingebaute Innenbeleuchtung.
- in aktuellem Betriebszustand

4 piece wagon set „Railjet“ of the Austrian Federal Railways.  
 Driving trailer with LED-lighting and two red LED tail lights.

- Item Nr. 64179 and 64180 (AC) are equipped with interior lighting.
- In current operating condition.



Set: 3-tlg. Railjet RJ 162, ÖBB / 3 piece set Railjet RJ 162, ÖBB



Ep VI

909

Art. Nr.: 64181	=	€ 189,00
Art. Nr.: 64182	= ⚡	€ 229,00
Art. Nr.: 64183	~ ⚡	€ 229,00

3-teiliges Wagenset „Railjet“ der Österreichischen Bundesbahnen.  
 Nachbildung der Inneneinrichtung der unterschiedlichen Klassen, feine Wagenübergänge.

- Die Art. Nr. 64182 und 64183 (AC) verfügen ab Werk über eine eingebaute Innenbeleuchtung.
- in aktuellem Betriebszustand

3 piece wagon set „Railjet“ of the Austrian Federal Railways.  
 Replicas of the interior design in the different classes. Elaborately designed intercar links.

- Item Nr. 64182 and 64183 (AC) are equipped with interior lighting.
- In current operating condition.

## Elektrolokomotive 2010, SNCB / Electric locomotive 2010, SNCB



Art. Nr.: 72667 = € 169,00

Art. Nr.: 78668 ~ € 244,00

Art. Nr.: 72668 = € 244,00



Motor mit Schwungmasse, Antrieb auf vier Achsen, davon zwei Achsen mit Haftreifen. Zweilicht-Spitzenbeleuchtung weiß/rot mit der Fahrtrichtung wechselnd.

Motor with flywheel. Drive on four axles, two of them have traction tyres. Dual headlights (red/white) that change with the direction of travel.

## Elektrolokomotive Ae 8/8 273, BLS / Electric locomotive type Ae 8/8 273, BLS



Art. Nr.: 72604 = € 279,00

Art. Nr.: 78604 ~ € 319,00

Motor mit Schwungmasse. Beide Lohkalfthen angetrieben. Antrieb auf acht Achsen. Typischer Schweizer Lichtwechsel.

- Neue Betriebsnummer der erhalten gebliebenen Lok 273 im letzten Betriebszustand.

Motor with flywheel. Both parts of the locomotive are driven. Drive on six axles. Typical Swiss light changeover.

- New running number of the locomotive 273 that is preserved in its last operating status.



Elektrolokomotive 420 268 „Gottardo“, SBB / Electric locomotive 420 268 „Gottardo“, SBB



Ep VI

177

PluX22



Motor mit Schwungmasse. Antrieb auf vier Achsen, zwei Haftreifen. LED-Spitzenlicht, Lichtwechsel nach Schweizer Vorbild.

■ Art. Nr. 73253 und 79253 mit digital schaltbaren Soundfunktionen.

Motor with flywheel. Drive on four axes, two traction tyres. LED-lighting changeover true to the Swiss original.

■ Item Nr. 73253 und 79253 with digitally switchable sound functions.

Art. Nr.: 73252	=	€ 219,00
Art. Nr.: 79253	~	€ 289,00

Art. Nr.: 73253	=	€ 289,00
-----------------	---	----------



Durch und durch die Schweiz.

Anlässlich der Gotthard-Tunnel-Eröffnung im Jahre 2016 legt Roco in einer begrenzten Stückzahl die beiden Lokomotiven im „Gottardo 2016“ Design auf. Die Lieferung der Modelle erfolgt zur feierlichen Eröffnung des Gotthard-Tunnels.

Swiss to the backbone.

When the Gotthard tunnel is officially opened in 2016, Roco launches the limited edition of the two locomotives in „Gottardo 2016“ design. The models were produced to mark the occasion of the grand opening of the Gotthard tunnel.

Elektrolokomotive 460 098 „Gottardo“, SBB / Electric locomotive 460 098 „Gottardo“, SBB



Ep VI

212

PluX22



Motor mit Schwungmasse. Antrieb auf vier Achsen, zwei Haftreifen. LED-Spitzenlicht, Lichtwechsel nach Schweizer Vorbild. Mit neu konstruiertem, fein ausgeführtem Faiveley-Stromabnehmer.

■ Art. Nr. 73279 und 79279 mit digital schaltbaren Soundfunktionen.

Motor with flywheel. Drive on four axes. Two traction tyres. LED-lighting changeover true to the Swiss original. The model features Faiveley pantographs that have a new design and many intricate details.

■ Item Nr. 73279 und 79279 with digitally switchable sound functions.

Art. Nr.: 73278	=	€ 189,00
Art. Nr.: 79279	~	€ 259,00

Art. Nr.: 73279	=	€ 259,00
-----------------	---	----------

## Elektrolokomotive Re 460 mit Kamera, SBB / Electric locomotive class 460 with cam, SBB



Ep VI

212

PluX22

Art. Nr.: 73280



€ 429,00

Art. Nr.: 79280



€ 429,00



Motor mit Schwungmasse. Antrieb auf vier Achsen, zwei Haftreifen. LED-Spitzenlicht, Lichtwechsel nach Schweizer Vorbild. Mit neu konstruiertem, fein ausgeführtem Faiveley-Stromabnehmer. Ausgerüstet mit einer integrierten Kamera, deren Bild direkt über einen in der Lok eingebauten WLAN-Baustein auf ein WLAN-fähiges Endgerät (Smartphone, Tablet, PC, Fernseher) übertragen wird.

Motor with flywheel. Drive on four axes. Two traction tyres. LED-lighting changeover true to the Swiss original. The model features Faiveley pantographs that have a new design and many intricate details. The model is equipped with a built-in camera. The video image is directly transferred to a WIFI compatible device (Smartphone, Tablet, PC, TV).

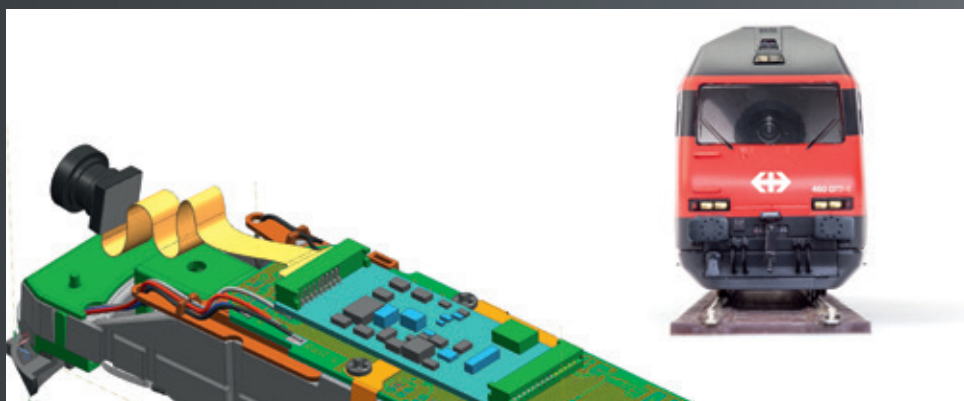

Mit der Kameralokomotive der Reihe 460 steht nun auch den Schweizerischen Modelleisenbahnern ein innovatives Produkt zur Verfügung. Eine ausgeklügelte Technik macht die 460 zur annähernd echten Lokomotive auf Ihrer Modellbahnanlage. In einem Führerstand ist eine kleine, kaum sichtbare Kamera eingebaut, die über

ein sehr großes Weitwinkelobjektiv verfügt. Damit werden nicht realitätsgetreue Verzerrungen an den Bildrändern vermieden. Wie ein echter Lokführer wird die komplette Frontansicht auf Ihr Smartphone, Tablet oder Ihren Computer übertragen. Eingebildet kann dabei auch der vorbildgerecht, passende Führerstand werden.

Noch mehr Spielspaß kommt auf, wenn das Modell in Kombination mit der innovativen Z21 Steuerung bedient wird. Hier kann jeder Hebel wie beim großen Original bedient werden und das Modell setzt sich langsam in Bewegung. So kommt auf der heimischen Modellbahnanlage noch mehr Freude an der Eisenbahn auf. Erzeugt wird das Kamerabild via eingebautem WLAN Modul, welches das Bild direkt an das Endgerät sendet. Zur Überbrückung von Spannungsunterbrechungen verfügen die Modelle über einen großzügig bemessenen Pufferkondensator.

Swiss railway modellers have now been put fully in the picture too with the introduction of our latest innovation – the class 460 camera locomotive. Sophisticated technology makes sure this 460 is as close as possible to being a real standard locomotive.

A tiny and scarcely visible camera is installed concealed away in the driver's cab, and a wide-angled lens provides an extraordinarily broad view image. This cuts out any unrealistic distortions that are not true to life. The complete frontal view is transmitted to your smartphone, tablet or computer in exactly the same way as it is for a real train driver. What's more, the exact cab (true to the original) can also be displayed. You have far more real railway fun when you combine this model with the innovative Z21 control system. All the control levers are operated here exactly as they are in the real original and the model is set slowly into motion. This makes a domestic model railway system even more fun. The image the camera captures is created via an installed WLAN module, which transmits it direct to your terminal device. These models have generous buffer capacitors to bridge any voltage dips.

Elektrolokomotive 460 036, SBB / Electric locomotive 460 036, SBB



Ep VI

212

PluX22



Photo: Ueli Schädegg

Art. Nr.: 73270	=	€ 199,00
Art. Nr.: 79271	~	€ 269,00

Art. Nr.: 73271	=	€ 269,00
-----------------	---	----------



Motor mit Schwungmasse. Antrieb auf vier Achsen, zwei Haftreifen. LED-Spitzenlicht, Lichtwechsel nach Schweizer Vorbild. Mit neu konstruiertem, fein ausgeführtem Faiveley-Stromabnehmer.

- Aufwendig bedrucktes Modell im „Japan“-Werbedesign.

Motor with flywheel. Drive on four axles. Two traction tyres. LED-lighting changeover true to the Swiss original. The model features Faiveley pantographs that have a new design and many intricate details.

- Lavishly printed special model in „Japan“ advertising design.

Elektrolokomotive 482 018, SBB Cargo / Electric locomotive 482 026, SBB Cargo



Ep VI

217

NEM 652



Motor mit Schwungmasse. Antrieb auf vier Achsen, zwei Haftreifen. Dreilicht-Spitzenlicht weiß/rot mit der Fahrtrichtung wechselnd.

- Einsatz vor internationalen Güterzügen.
- Passende Güterwagen: Doppeltaschenwagen T2000 (Seite 84 ff.).

Motor with flywheel. Drive on four axles. Traction tyres. White/red triple headlight that change with the direction of travel.

- Use for international freight trains.
- Suitable goods wagons: Double pocket wagon T2000 (Page 84 ff.).



Art. Nr.: 73597	=	€ 189,00
-----------------	---	----------

Art. Nr.: 79597	~	€ 229,00
-----------------	---	----------

Elektrolokomotive 465 017 „Pink Panther“, BLS / Electric locomotive 465 017 „Pink Panther“, BLS



BLS

Ep VI

212

PluX22

Motor mit Schwungmasse. Antrieb auf vier Achsen, zwei Haftreifen.  
LED-Spitzenlicht, Lichtwechsel nach Schweizer Vorbild.  
Lokomotive in aktueller Ausführung wie sie für das Unternehmen Railcare im Einsatz ist.

- Ausführung im Design „Pink Panther“.

Motor with flywheel. Drive on four axes. The model features two traction tyres.  
LED-lighting, changeover according to the Swiss original locomotive.

Locomotive in current design as it is in operation for the company Railcare.

- Version in „Pink Panther“ design.



Photo: Adrian Kammermann

Art. Nr.: 73274 = € 199,00

Art. Nr.: 73275 = € 269,00

Art. Nr.: 79275 ~ € 269,00

Elektrolokomotive 465 018 „Flash Fire“, BLS / Electric locomotive 465 018 „Flash Fire“, BLS



BLS

Ep VI

212

PluX22



Photo: Adrian Kammerman

Motor mit Schwungmasse. Antrieb auf vier Achsen, zwei Haftreifen.  
LED-Spitzenlicht, Lichtwechsel nach Schweizer Vorbild.  
Lokomotive in aktueller Ausführung wie sie für das Unternehmen Railcare im Einsatz ist.

- Ausführung im Design „Flash Fire“.

Motor with flywheel. Drive on four axes. The model features two traction tyres.  
LED-lighting, changeover according to the Swiss original locomotive.

Locomotive in current design as it is in operation for the company Railcare.

- Version in „Flash Fire“ design.

Art. Nr.: 73272 = € 199,00

Art. Nr.: 73273 = € 269,00

Art. Nr.: 79273 ~ € 269,00

### Elektr locomotive BR 186, Railpool / Electric locomotive class 186, BLS



PRIVAT

Ep VI

217

NEM 652



Art. Nr.: 73666 € 189,00 Art. Nr.: 79666 € 229,00

Motor mit Schwungmasse, Antrieb auf vier Achsen, eine Achse mit Haftreifen. LED-Spitzenlicht weiß/rot mit der Fahrtrichtung wechselnd.

- Ausführung im BLS Cargo Werbedesign.
- Passende Güterwagen: Doppeltaschenwagen T2000 (Seite 84ff.).

Motor with flywheel, drive on four axles, two of them have traction tyres. LED-lighting white/red that change with the direction of travel.

- Version in BLS Cargo advertising design.
- Suitable goods wagons: Double pocket wagon T2000 (Page 84 ff.).

### Elektr locomotive BR 185, Captrain / Electric locomotive class 185, Captrain



PRIVAT

Ep VI

217

NEM 652

Motor mit Schwungmasse, Antrieb auf vier Achsen, eine Achse mit Haftreifen. Dreilicht-Spitzenbeleuchtung weiß/rot mit der Fahrtrichtung wechselnd.

Motor with flywheel, drive on four axles, two of them have traction tyres. Triple headlights white/red that change with the direction of travel.



Art. Nr.: 73599 € 179,00 Art. Nr.: 79599 € 219,00

## Elektrolokomotive 103 118, DB / Electric locomotive 103 118, DB



Ep IV

224

PluX22



Art. Nr.: 72278



€ 199,00

Art. Nr.: 72279



€ 274,00

Art. Nr.: 78279



€ 274,00



Sound

Modell mit LED-Spitzenlicht weiß/rot mit der Fahrtrichtung wechselnd. Motor mit Schwungmasse. Antrieb auf sechs Achsen, zwei davon mit Haftreifen.

- Eine passende Zuggarnitur „IC Deichgraf“ finden Sie auf Seite 50.
- Ausführung mit kurzem Führerstand und rotem DB-Logo.

Model with LED-lighting and two red tail lights that change with the direction of travel. Motor with flywheel. Drive on six axles, two of them with traction tyres.

- Suitable train unit „IC Deichgraf“ at page 50.
- Version with short driver's cabin and red DB-logo.

## Elektrolokomotive BR 103, DB / Electric locomotive class 103, DB



Ep IV-V

224

PluX22

Modell mit LED-Spitzenlicht weiß/rot mit der Fahrtrichtung wechselnd. Motor mit Schwungmasse. Antrieb auf sechs Achsen, zwei davon mit Haftreifen.

- Ausführung in orientroter Lackierung und kurzem Führerstand.

Model with LED-lighting and two red tail lights that change with the direction of travel. Motor with flywheel. Drive on six axles, two of them with traction tyres.

- Version in orient red livery and short driver's cabin.

Art. Nr.: 72281



€ 199,00

Art. Nr.: 72282



€ 274,00

Art. Nr.: 78282



€ 274,00



Sound



## Elektrolokomotive 103 240 mit Kamera, DB AG / Electric locomotive 103 240 with cam, DB AG



Ep V

232

PluX22



Art. Nr.: 72287



€ 429,00

Art. Nr.: 78287



€ 429,00

Sound

Modell mit LED-Spitzenlicht weiß/rot mit der Fahrtrichtung wechselnd. Motor mit Schwungmasse. Antrieb auf sechs Achsen, zwei Achsen mit Haftreifen. Ausgerüstet mit einer integrierten Kamera, deren Bild direkt über einen in der Lok eingebauten WLAN-Baustein auf ein WLAN-fähiges Endgerät (Smartphone, Tablet, PC, Fernseher) übertragen wird.

- Ausführung in orientroter Lackierung und langem Führerstand.

Model with LED-lighting (white/red) that change with the direction of travel. Motor with flywheel. Drive on six axles, two with traction tyres. This model is equipped with a build-in camera. The video image is directly transferred to a WIFI compatible device (Smartphone, Tablet, PC, TV).

- Version in orient red livery with long driver's cab.

### Elektrolokomotive BR 243, DR / Electric locomotive class 243, DR



Ep IV

192

PluX22



Art. Nr.: 73328	=	€ 179,00
Art. Nr.: 79329	~ 🔊	€ 249,00

Art. Nr.: 73329	= 🔊	€ 249,00
-----------------	-----	----------



Modell mit eckigem Dach, fein detailliert mit vielen filigranen angesetzten Teilen, zum Teil in geätzter Ausführung. Motor mit Schwungmasse, Antrieb auf vier Achsen, eine Achse mit Haftreifen. LED-Spitzenlicht. Ab 1984 wurden die E-Loks der Baureihe 243 an die Deutsche Reichsbahn für den Personenzug- und mittelschweren Güterzugdienst geliefert. Insgesamt wurden über 600 Fahrzeuge dieser Baureihe von der DR abgenommen.

Rich detailing on the revised model with angular roof and many lavishly designed plug-in parts that are partially etched. Model is driven by an engine with mass flywheel on four axles of which one features traction tyres. LED-lighting. From 1984 onwards, the class 243 electric locomotives were delivered to Deutsche Reichsbahn for use on passenger as well as medium-heavy freight traffic. A total of 600 locomotives in this class were purchased by the DR.

### Elektrolokomotive BR 114, DB AG / Electric locomotive class 114, DB AG



Ep V-VI

192

PluX22

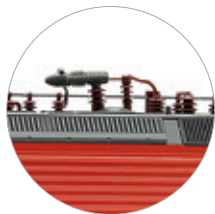

Art. Nr.: 73324	=	€ 179,00
Art. Nr.: 79325	~ 🔊	€ 249,00

Art. Nr.: 73325	= 🔊	€ 249,00
-----------------	-----	----------



Modell fein detailliert mit vielen filigranen angesetzten Teilen, zum Teil in geätzter Ausführung. Motor mit Schwungmasse, Antrieb auf vier Achsen, eine Achse mit Haftreifen. LED-Spitzenlicht. Die Elektrolokomotiven der Baureihe 114 werden vorrangig in Personennahverkehr eingesetzt.

Rich detailing on the revised model with many elaborately applied plug-in parts, partially in etched design. Model is driven by an engine with mass flywheel on four axles of which one features traction tyres. LED-lighting. The electric locomotives of the class 114 are used preferentially for local passenger traffic.

## Elektrolokomotive 111 123 „500 Jahre Reinheitsgebot“, DB AG / Electric locomotive 111 123 „500 Years Purity Law“, DB AG



Ep VI

190

NEM 652



Abbildungen zeigen retuschierte Grafikezeichnungen / Illustrations depict retouched drawings

Art. Nr.: 73412

€ 189,00

Art. Nr.: 79412

€ 229,00



Motor mit Schwungmasse, Antrieb auf vier Achsen, zwei Haftreifen. Dreilicht-Spitzensignal weiß/rot mit der Fahrtrichtung wechselnd.

- Aufwendige Bedruckung im Sonderdesign anlässlich des Jubiläums „500 Jahre Reinheitsgebot des Bieres“ im Jahre 2016.

Motor with flywheel. Drive on four axes, two traction tyres. Triple headlights that switch with the direction of travel (white/red).

- For the festival celebrating „500 Years Beer Purity Law“ the locomotive was decorated with a special design featuring intricate printing.



Das älteste Lebensmittelgesetz der Welt feiert Geburtstag! Das Reinheitsgebot wird 500 Jahre alt und das ist für die Deutsche Bahn AG, DB Regio Bayern und natürlich Roco ein Grund zum Feiern. Erstmals wird das Reinheitsgebot in einem Sitzungsprotokoll des bayerischen Landtags am 4. März 1918 belegt. Aber bereits im Jahre 1516 finden sich geschichtliche Hinweise auf die Einführung dieses Gebots. Es besagt neben Angaben zum Maß oder dem Preis für ein Bier vor allem die Zutaten, die für das Brauen des Bieres verwendet werden dürfen. Nämlich ausschließlich Gerste, Hopfen und natürlich Wasser. Aus diesem Grund wird Ende Januar 2016 die 111 123 in einem speziellen von Gudrun Geiblinger gestalteten Design in Ingolstadt vorgestellt. Gleichzeitig mit der Premiere der neuen Werbelok beginnt in Bayern auch das Jubiläumsjahr zum Thema „500 Jahre Reinheitsgebot“. Wir stoßen mit an und legen das Modell in einer begrenzten Auflage im Maßstab 1:87 auf. Das große Vorbild wird für mehrere Jahre in Bayern sowie in den benachbarten Bundesländern zum Einsatz kommen.

The oldest food legislation in the world celebrates an anniversary! The „Reinheitsgebot“ (or beer purity law) was established 500 years ago. Reason enough for the Deutsche Bahn AG, DB Regio Bayern and of course also for Roco to raise their glasses, so to speak. The first official mention of the purity law dates back to minutes of a meeting of the Bavarian Parliament of 4 March 1918; but there is historic evidence that the law was introduced as early as in 1516. Besides specifying the quantity of a „Mass“ (Bavarian litre 1.069) and the price of beer, the law names the only ingredients that are allowed to be used in beer brewing: barley, hops and water. To celebrate the anniversary, the 111 123 model will be launched in a special design of Gudrun Geiblinger in Ingolstadt at the end of January 2016. The première of the new advertising locomotive coincides with the start of the brewing anniversary year in Bavaria celebrating „500 years of Reinheitsgebot“. We congratulate and launch the model in a limited 1:87 HO scale edition. The full sized original will be a familiar sight throughout Bavaria and the neighbouring German States for several years to come.



Elektrolokomotive 146 247 „Vernetzt in die Zukunft“, DB AG / Electric locomotive 146 247 „Vernetzt in die Zukunft“, DB AG



Ep VI

217

NEM 652



Handmuster / handmade model

Art. Nr.: 73674 € 229,00      Art. Nr.: 79674 € 269,00

Motor mit Schwungmasse, Antrieb auf vier Achsen, zwei Haftreifen. LED-Spitzenlicht weiß/rot mit der Fahrtrichtung wechselnd.

■ Aufwendige Bedruckung im Sonderdesign.

Engine with mass flywheel drive on all four axles, two traction tyres. LED-lighting white and red that changes with the direction of travel.

■ Lavishly printed in special design.



Seit 31. Juli 2015 fährt die Elektrolokomotive 146 247-2 in ihrem auffälligen Sonderdesign zum Thema „Mobilität der Zukunft“ durch Bayern und durch die benachbarten Bundesländer. Gestaltet wurde die Lokomotive von Gudrun Geiblinger. Die Lokomotive bewirbt neben den verschiedenen Applikationen, die bei der Deutschen Bahn für die Fahrgäste zur Verfügung stehen auch das

Bahnland Bayern. Dies verdeutlicht die angedeutete, bayerische Landkarte. Die Lokomotive der Baureihe 146.2 kommt aber nicht nur in Bayern zum Einsatz. Auch bis Frankfurt am Main fährt die Lokomotive. Für mehrere Jahre wird die von Bahnvorstand Dr. Rüdiger Grube getaufte Lokomotive nun in Betrieb sein.

The electric locomotive 146 247-2 in its spectacular special design reflecting the topic of „Mobility of the Future“ has been pacing through Bavaria and the neighbouring German States since 31 July 2015. The locomotive was designed by Gudrun Geiblinger. In addition to the various apps made available by the Deutsche Bahn for passengers, the locomotive is also a great advertisement for railway travel in Bavaria; a fact invitingly illustrated by the outline map of Bavaria. This Class 146.2 locomotive is not only used in Bavaria, it also serves on routes as far as Frankfurt am Main. The locomotive, baptised by Deutsche Bahn CEO Dr. Rüdiger Grube, will operate for several years.



C. Auerweck

Elektrolokomotive 185 417, TX Logistik / Electric locomotive 185 417, TX Logistik



PRIVAT

Ep VI

217

NEM 652



Motor mit Schwungmasse. Antrieb auf vier Achsen, zwei Haftreifen. LED-Spitzenlicht rot/weiß mit der Fahrtrichtung wechselnd.

- Passende Wagen: Doppeltaschenwagen T2000 (Seite 84ff.).

Motor with flywheel. Drive on four axles. Two traction tyres. Red/white LED-lighting that change with the direction of travel.

- Suitable goods wagons: Double pocket wagon T2000 (Page 84 ff.).

Art. Nr.: 73598



€ 179,00

Art. Nr.: 79598



€ 219,00

# Lokomotion

Seit vielen Jahren zählen die bunt gestalteten Lokomotiven des privaten Bahnunternehmens Lokomotion zu einem gewohnten Bild auf unseren Schienen. Jeder Eisenbahnfreund kennt die im auffälligen Zebra-Design gestalteten Lokomotiven.

Umfasste der Lokomotion-Fuhrpark anfangs nur gemietete Lokomotiven, so sind heute betriebseigene Lokomotiven im Einsatz. Hierzu zählen seit 2015 auch die Elektrolokomotiven der Baureihen 151 und 186.

The colourful locomotives of the private railway company „Lokomotion“ have become a regular sight on our railway tracks. Every railwayman and railwaywoman knows the locomotives with their striking zebra design.

While the locomotive range originally included leased locomotives only, the company now operates its own locomotives, includes class 151 and 186 electric locomotives that were added to the fleet in 2015.



## Elektr locomotive 186 443, Railpool / Electric locomotive 186 443, Railpool



PRIVAT

Ep VI

217

NEM 652

Motor mit Schwungmasse, Antrieb auf vier Achsen, eine Achse mit Haftreifen. LED-Spitzenlicht automatisch mit der Fahrtrichtung wechselnd.

- Passende Wagen: Doppeltaschenwagen T2000 (Seite 84ff.).

Motor with flywheel, drive on four axles, one of them has traction tyres. LED-lighting that automatically change with the direction of travel.

- Suitable goods wagons: Double pocket wagon T2000 (Page 84 ff.).

Art. Nr.: 73667



€ 189,00

Art. Nr.: 79667



€ 229,00



C. Auerweck

## Elektr locomotive 151 056, Lokomotion / Electric locomotive 151 056, Lokomotion



PRIVAT

Ep VI

224

PluX22



Art. Nr.: 73434



€ 199,00

Art. Nr.: 73435



€ 269,00



Sound

Motor mit Schwungmasse. Antrieb auf sechs Achsen, zwei Räder mit Haftreifen. LED-Spitzenlicht weiß/rot mit der Fahrtrichtung wechselnd.

- Viele extra angesetzte Steckteile, teilweise in Ätztechnik.

Motor with mass flywheel. Drive on six axles. Two wheels are equipped with traction tyres. Red/white triple LED-lighting white/red that change with the direction of travel.

- Many separately fitted etched parts.

Art. Nr.: 79435



€ 269,00

## Elektr locomotive 189 927, Lokomotion / Electric locomotive 189 927, Lokomotion



PRIVAT

Ep VI

225

NEM 652

Motor mit Schwungmasse. Antrieb auf vier Achsen, zwei Haftreifen. Dreilicht-Spitzenbeleuchtung mit der Fahrtrichtung wechselnd.

Lokomotive vermietet an das private Eisenbahnunternehmen Lokomotion Gesellschaft für Schienentraktion mbH.

Motor with flywheel. Drive on four axes. Two traction tyres. Triple headlight that changes with the direction of travel.

Electric locomotive hired out to the private railways company Lokomotion Gesellschaft für Schienentraktion mbH.

Art. Nr.: 73635



€ 189,00

Art. Nr.: 79635



€ 229,00



Elektrolokomotive Serie 2D2, SNCF / Electric locomotive series 2D2, SNCF



Motor mit Schwungmasse. Antrieb auf vier Achsen, zwei Haftreifen. LED-Spitzenlicht mit der Fahrtrichtung wechselnd.

- Modell in Bicolor Ursprungsausführung mit neuer Betriebsnummer.
- Mit niedrigen Spurkränzen.

Motor with mass flywheel. Drive on four axles. Two wheels are equipped with traction tyres. LED-lighting that changes with the direction of travel.

- Model in bicolor original design with new running number.
- With low wheel flanges.



Ep III

200

NEM 652



Art. Nr.: 73483



€ 249,00

Art. Nr.: 79483



€ 289,00

Elektrolokomotive 2D2 9101, SNCF / Electric locomotive 2D2 9101, SNCF

**Formvariante  
Modified Tooling**

Motor mit Schwungmasse. Antrieb auf vier Achsen, zwei Haftreifen. LED-Spitzenlicht mit der Fahrtrichtung wechselnd.

- Modell in Unicolor-Lackierung
- Mit vorbildgerechten Formänderungen
- Betriebsnummer: 9101

Motor with mass flywheel. Drive on four axles. Two wheels are equipped with traction tyres. LED-lighting that changes with the direction of travel.

- Model in unicolor livery
- With modified tooling, true to the original
- Running number: 9101



Ep IV

200

NEM 652



Art. Nr.: 73482



€ 249,00

Art. Nr.: 79482



€ 289,00

### Elektr locomotive BB522227, SNCF / Electric locomotive BB522227, SNCF



Ep VI

200

NEM 652



Art. Nr.: 72649



€ 139,00

Motor mit Schwungmasse, Antrieb auf vier Achsen, zwei Haftreifen. LED-Spitzenlicht mit der Fahrtrichtung wechselnd.

Motor with flywheel. Drive on four axes. Two traction tyres. LED-lighting that switch with the direction of travel.

### Elektr locomotive BR 186, SNCF / Electric locomotive class 186, SNCF



Ep VI

217

NEM 652

Motor mit Schwungmasse, Antrieb auf vier Achsen, zwei Haftreifen, LED-Spitzenlicht weiß/rot mit der Fahrtrichtung wechselnd.

- Modell mit separat angesetzten Steckteilen.

Engine with flywheel, drive on four axes, two traction tyres, LED-lighting that changes automatically with the direction of travel.

- With separately applied plug-in parts.



Art. Nr.: 73663



€ 189,00

Art. Nr.: 79663



€ 229,00

### Elektr locomotive BR 186, ECR / Electric locomotive class 186, ECR



PRIVAT

Ep VI

217

NEM 652



Motor mit Schwungmasse, Antrieb auf vier Achsen, zwei Haftreifen, LED-Spitzenlicht weiß/rot mit der Fahrtrichtung wechselnd.

- Modell mit separat angesetzten Steckteilen.
- Ausführung der Euro Cargo Rail, einem Gemeinschaftsunternehmen der DB AG und der SNCF.

Engine with flywheel, drive on four axes, two traction tyres, LED-lighting that changes automatically with the direction of travel.

- With separately applied plug-in parts.
- Version of the euro Cargo Rail, a common company of DB AG and SNCF.

Art. Nr.: 73664



€ 189,00

Art. Nr.: 79664



€ 229,00

## Elektrolokomotive E.444, FS / Electric locomotive E.444, FS



Ep IV

195

NEM 652

Motor mit Schwungmasse. Antrieb auf vier Achsen, zwei Haftreifen. LED-Spitzenlicht mit der Fahrtrichtung wechselnd.

- Einsatz vor hochwertigen Reisezügen

Motor with flywheel. Drive on four axles, two traction tyres. LED-lighting that change with the direction of travel.

- Locomotive used for hauling prestigious passenger trains.



Art. Nr.: 73346



€ 189,00

Art. Nr.: 73347



€ 269,00

Art. Nr.: 79347



€ 269,00

## Elektrolokomotive E.412 013, FS / Electric locomotive E.412 013, FS



Ep VI

223

NEM 652



Art. Nr.: 73567



€ 149,00

Motor mit Schwungmasse. Antrieb auf vier Achsen, zwei Haftreifen. Dreifach-Spitzenbeleuchtung mit der Fahrtrichtung wechselnd. Fein detailliertes Modell.

- Design mit Schriftzug „Partners for your goods“.
- Die Lokomotive ist vorrangig vor Güterzügen in Italien, Österreich und Deutschland im Einsatz.

Engine with mass flywheel. Drive on four axles, two traction tires. Triple headlight that changes with the direction of travel. Rich detailing on the model in current design.

- Design with Branding „Partners for your goods“.
- The locomotive mainly hauls freight trains in Italy, Austria and Germany.

## Elektrolokomotive E.412 015, FS / Electric locomotive E.412 015, FS



Ep VI

223

NEM 652

Motor mit Schwungmasse. Antrieb auf vier Achsen, zwei Haftreifen. Dreifach-Spitzenbeleuchtung mit der Fahrtrichtung wechselnd. Fein detailliertes Modell.

- Die Lokomotive ist vorrangig vor Güterzügen in Italien, Österreich und der Schweiz im Einsatz.

Engine with mass flywheel. Drive on four axles, two traction tires. Triple headlight that changes with the direction of travel. Rich detailing on the model in current design.

- The locomotive mainly hauls freight trains in Italy, Austria and Switzerland.



Art. Nr.: 73568



€ 149,00

### Elektrolokomotive E.655, FS / Electric locomotive E.655, FS



Motor mit Schwungmasse. Antrieb auf vier Achsen, zwei Haftreifen.  
LED-Spitzenlicht mit der Fahrtrichtung wechselnd.

- Einsatz auch im grenzüberschreitenden Verkehr nach Slowenien.

Motor with flywheel. Drive on four axles, two traction tyres.  
LED-lighting that change with the direction of travel.

- The model is used for the cross border traffic to Slovenia.

Ep VI

210

NEM 652

Art. Nr.: 72663 € 189,00      Art. Nr.: 78663 € 229,00

### Elektrolokomotive E.483, DB AG Italia / Electric locomotive E.483, DB AG Italia



Motor mit Schwungmasse, Antrieb auf vier Achsen, eine Achse mit Haftreifen,  
LED-Spitzenlicht automatisch mit der Fahrtrichtung wechselnd.

- Unter DB Schenker Rail Italia Services ist die Vorbildlokomotive im italienischen Güterverkehr im Einsatz.

Motor with flywheel, drive on four axles, one of them has traction tyres, LED-lighting that automatically change with the direction of travel.

- The DB Schenker Rail Italia Services use the locomotive for Italian freight traffic.



Ep VI

217

NEM 652

Art. Nr.: 73669 € 189,00      Art. Nr.: 79669 € 229,00

### Elektrolokomotive 484 103, MRCE / Electric locomotive 484 103, MRCE



Motor mit Schwungmasse, Antrieb auf vier Achsen, eine Achse mit Haftreifen,  
LED-Spitzenlicht automatisch mit der Fahrtrichtung wechselnd.

- Ausführung für den Italien-Schweiz-Verkehr.

Motor with flywheel, drive on four axles, one of them has traction tyres,  
LED-lighting that automatically change with the direction of travel.

- This version is used in the Italian/Swiss traffic.

Ep VI

217

NEM 652

Art. Nr.: 73676 € 189,00      Art. Nr.: 79676 € 229,00

Elektrolokomotive 1212, NS / Electric locomotive 1212, NS

  
  
  
 Ep IV  
 208  
 PluX22



Motor mit Schwungmasse, LED-Spitzenlicht mit der Fahrtrichtung wechselnd, Antrieb auf sechs Achsen, eine Achse mit Haftreifen.

- Fein detaillierte Ausführung mit vielen separat angesetzten Steckteilen, teilweise in Ätztechnik.
- Art. Nr. 73831 und 79831 mit digital schaltbaren Soundfunktionen.

Motor with flywheel, LED-lighting that change with the direction of travel, drive on six axles, one of them has traction tyres to increase traction power.

- Rich detailing on the model with many separately applied plug-in parts that are partially etched.
- Item Nr. 73831 und 79831 with digitally switchable sound functions.

Art. Nr.: 73830 = € 249,00    Art. Nr.: 73831 =  € 324,00    Art. Nr.: 79831 ~  € 324,00

Elektrolokomotive BR 119, Alpha Trains / Electric locomotive class 119, Alphatrain

  
  
 PRIVAT  
 Ep VI  
 217  
 NEM 652



Motor mit Schwungmasse. Antrieb auf vier Achsen, zwei Haftreifen. LED-Spitzenlicht mit der Fahrtrichtung wechselnd.

- Vermietet an das EVU Rhein Cargo.

Motor with flywheel. Drive on four axles, two traction tyres. LED-lighting that change with the direction of travel.

- Hired out to EVU Rhein Cargo.

Art. Nr.: 73673 = € 179,00    Art. Nr.: 79673 ~ € 219,00



### Elektrolokomotive EL18, NSB / Electric locomotive EL18, NSB



Motor mit Schwungrad. Antrieb auf vier Achsen, zwei Haftreifen. LED-Spitzenlicht mit der Fahrtrichtung wechselnd.

Ep VI

212

PluX22



Art. Nr.: 73638	=	€ 189,00
Art. Nr.: 73639	= 🔊	€ 259,00
Art. Nr.: 79639	~ 🔊	€ 259,00

### Elektrolokomotive Rc4 1290, SJ / Electric locomotive Rc4 1290, SJ



Ep VI

179

PluX22

Art. Nr.: 73440	=	€ 199,00
Art. Nr.: 73441	= 🔊	€ 274,00
Art. Nr.: 79441	~ 🔊	€ 274,00

Motor mit Schwungrad, Antrieb auf vier Achsen, zwei Haftreifen. LED-Spitzenlicht mit der Fahrtrichtung wechselnd.

- In Retrodesign Lackierung der Green Cargo anlässlich des Bahn Jubiläums „100 Jahre elektrischer Betrieb in Schweden“.

Motor with flywheel. Drive on four axes. Two traction tyres. LED-lighting that switch with the direction of travel and red tail light.

- Model in Green Cargo Retro Design livery designed for the Railway Anniversary in Sweden.

### Elektrolokomotive BR 370, PKP / Electric locomotive class 370, PKP



Ep VI

NEM 652

225

Art. Nr.: 73492	=	€ 219,00
Art. Nr.: 73493	= 🔊	€ 289,00

Motor mit Schwungrad. Antrieb auf vier Achsen, zwei Haftreifen. LED-Spitzenlicht mit der Fahrtrichtung wechselnd.

- Aufwendige Bedruckung im aktuellen T-Mobile Werbedesign.
- Im grenzüberschreitenden Verkehr nach Deutschland im Einsatz.

Motor with flywheel. Drive on four axes. Two traction tyres. LED-lighting that changes with the direction of travel.

- Lavishly printed in current T-Mobile advertising design.
- The model is used for the cross border traffic to Germany.



**Grafikentwurf**  
Conceptual design

Elektrische Doppellokomotive IORE, LKAB / Electric double locomotive IORE, LKAB



- passende Wagen: Art. Nr. 67174 (Seite 94)
- suitable wagons: Item Nr. 67174 (Page 94)



LKAB

Ep VI

525

NEM 652



Abbildung zeigt unretuschiertes Handmuster. / Illustration depicts non retouched model.

Art. Nr.: 72657	=	€ 249,00
Art. Nr.: 72658	=	€ 379,00
Art. Nr.: 78658	~	€ 379,00

Motor mit Schwungmasse. Antrieb auf zwölf Achsen, acht Haftreifen. Dreilicht-Spitzenbeleuchtung mit der Fahrtrichtung wechselnd.

- Im aktuellen Betriebszustand
- Wiederauflage mit geänderter Betriebsnummer und Loknamen.
- Art. Nr. 72658 und 78658 mit digital schaltbaren Soundfunktionen.

Motor with flywheel. Drive on twelve axles. Eight traction tyres. Triple headlights that change with the direction of travel.

- In current operating condition
- Re-release with a altered running number.
- Item. Nr. 72658, 78658 with digitally switchable sound functions.

Elektrolokomotive EI 16, TGOJ Trafik / Electric locomotive EI 16, TGOJ Trafik



PRIVAT

Ep VI

180

PluX22



Art. Nr.: 73384 = € 219,00

Art. Nr.: 73385 = € 294,00

Art. Nr.: 79385 ~ € 294,00

Motor mit Schwungmasse, Antrieb auf vier Achsen, zwei Haftreifen. LED-Spitzenlicht mit der Fahrtrichtung wechselnd.

- Viele extra angesetzte Steckteile, teilweise in Ätztechnik.
- Die Lokomotive ist in Norwegen und Schweden im Einsatz.

Motor with flywheel. Drive on four axles, two traction tyres. LED-lighting that change with the direction of travel.

- Many separately fitted etched parts.
- The locomotive is in service in Norway and Sweden.



Diesellokomotive 2067 087, ÖBB / Diesel locomotive 2067 087, ÖBB



Ausführung im Valousek-Design (verkehrsrot/achatgrau/umbragrau). Motor mit Schwungmasse, LED-Spitzenlicht. Pufferkondensator bei den Modellen in Digital-Ausführung.

- Feine Radsätze mit niedrigen Spurkränzen
- Motorvorbau mit nachgebildeter Schubhaube
- Mit überarbeitetem Fahrwerk

Ep V

120

PluX22

Model in Valousek design (traffic red/agate grey/umbra grey). Engine with mass flywheel, LED-lighting. Digital models are equipped with buffer capacitors.

- Elaborately designed wheel sets with low flanges
- Motor with superstructure and pull-out hood replica
- Revised chassis



Photo: Ch. Brunner

Art. Nr.: 72906 € 179,00

Art. Nr.: 72907 € 249,00

Art. Nr.: 78907 € 249,00

Diesellokomotive Serie 62 Infrabel, SNCB / Diesel locomotive series 62 Infrabel, SNCB



Ep VI

193

NEM 652



Photo: Sig. Modelleisenbahn GmbH.

Motor mit Schwungmasse. Antrieb auf vier Achsen, zwei Haftreifen. Dreilicht-Spitzenbeleuchtung mit der Fahrtrichtung wechselnd.

Motor with flywheel. Drive on four axles, two traction tyres. Triple headlights that change with the direction of travel.

Art. Nr.: 72879 € 149,00

Art. Nr.: 78879 € 189,00

Diesellokomotive T478.4, CSD / Diesel locomotive T478.4, CSD

 Sound



CSD

Ep IV

190

NEM 652



Art. Nr.: 72962



€ 149,00

Art. Nr.: 72963



€ 219,00

Motor mit Schwungmasse. Antrieb auf vier Achsen, zwei Haftreifen. LED-Spitzenlicht mit der Fahrtrichtung wechselnd.

Motor with flywheel. Drive on four axles, two traction tyres. LED-lighting that switch with the direction of travel.

Diesellokomotive Rh 754, CD / Diesel locomotive class 754, CD

 Sound



Ep VI

190

NEM 652



Art. Nr.: 72948



€ 149,00

Art. Nr.: 72949



€ 219,00

Motor mit Schwungmasse. Antrieb auf vier Achsen, zwei Haftreifen. LED-Spitzenlicht mit der Fahrtrichtung wechselnd.

- Im aktuellen Betriebszustand

Motor with flywheel. Drive on four axles, two traction tyres. LED-lighting that switch with the direction of travel.

- In current operating condition



## Diesellokomotive BR 210, DB / Diesel locomotive class 210, DB



Ep IV

189

PluX22



Neukonstruktion  
New Design

Sound

Motor mit Schwungmasse. Antrieb auf vier Achsen, zwei Haftreifen. LED-Spitzenlicht weiß/rot mit der Fahrtrichtung wechselnd. Fein detailliertes Modell.

- Vorbildgerechte Formänderungen der Baureihe 210.
- Art. Nr. 73731 und 79731 mit digital schaltbaren Soundfunktionen.

Motor with flywheel. Drive on all four axles, two traction tyres. White/red triple LED-lighting white/red that change with the direction of travel. Rich detailing on the model.

- Modified tooling of the class 210, true to the original.
- Item Nr. 73731 and 79731 with digitally switchable sound functions



Abgashutze der Baureihe 210  
Exhaust hood of the series 210

Art. Nr.: 73730



€ 159,00

Art. Nr.: 73731



€ 229,00

Art. Nr.: 79731



€ 229,00

Für den Serienumbau einiger Exemplare der beliebten V160-Familie orderte die DB bei den damaligen Klöckner-Humboldt-Deutz Werken leistungsstarke Turbinen des Typs AVCO Lycoming T53-L13. Bereits bei der Deutschen Bundeswehr waren diese Turbinen erfolgreich im Hubschrauberbereich im Einsatz. Ab dem Jahre 1970 wurden diese Aggregate in den zur Baureihe 210 umgezeichneten Lokomotiven eingesetzt. Schnell kamen die Lokomotiven der Betriebsnummern 210 001-008 auf ihren angedachten Stammstrecken zum Einsatz. Zum täglichen Umlauf gehörte der klangvolle Schnellzug „TEE Bavaria“ sowie einige weitere schwere Eilzüge zwischen der bayerischen Landeshauptstadt München und Lindau. In den ersten Jahren war die Deutsche Bundesbahn mit den erzielten Leistungen der Baureihe 210 äußerst zufrieden. Lediglich im Winter musste zum Teil auf Doppeltraktion gesetzt werden, da die Heizleistung der 210 im Solo-Einsatz für die langen Schnellzüge zu gering war.

Aufgrund der häufigen Startvorgänge der Gasturbinen war der Verschleiß größer als erwartet. So kam es im März 1978 zu einem Zwischenfall, bei dem eines der Turbinenlaufräder zerbrach. Schnell wurden auch die öffentlichen Medien auf die nun vermehrt auftretenden Probleme bei den Diesellokomotiven aufmerksam. Nachdem es zu immer mehr Ausfällen der Maschinen gekommen war, entschloss sich die Deutsche Bundesbahn die Gasturbinen bei den 210ern auszubauen. In Folge dieses Umbaus erhielten die Fahrzeuge die neue Baureihenbezeichnung 218.9.

When the DB decided to convert some models of the popular V160 family, they ordered powerful turbines of the AVCO Lycoming T53-L13 type from the then Klöckner-Humboldt-Deutz plant. These turbines had proven their worth in German army helicopters. As from 1970, the turbines were used in the locomotives of the redesignated class 210. The locomotives with running numbers 210 001-008 were soon employed on their main routes. Their daily diagrams included the famous TEE Bavaria Express and some other fast and heavy duty trains between the Bavarian capital of Munich and Zurich. The Deutsche Bundesbahn was very satisfied with the performance of the Class 210 in the first few years. In winter double heading was required in some cases as the heating capacity of the class 210 proved inadequate for solo use on long express trains.

DB's satisfaction began to decline on 24 March 1978. A turbine failure on 210 003 was extensively covered by the media, which had already launched a discussion on the safety of gas turbines, caused a turbine runner to burst. And there were more incidents with gas turbines in the class 210 over the course of the next few months. It was found that the many starts during operation that were necessary to boost the main diesel reduced the service life of the gas turbine significantly. As a consequence, DB decided to remove the gas turbines and to use the locomotives under running numbers in the class 218.9 series again, this time in standard operation.

Diesellokomotive BR 333, DB / Diesel locomotive class 333, DB



Ep IV

90

NEM 652



72727: mit Digitalkupplung  
72727: with digital coupling

- Motor mit Schwungmasse. Antrieb auf zwei Achsen.
- In alterer Farbgebung
  - Art. Nr. 72727 mit Digitalkupplung ausgerüstet, ideal zum Rangieren im Vershub.
- Motor with mass flywheel. Drive on two axles.
- In ancient red livery
  - Item Nr. 72727 equipped with digital coupling, ideal for shunting.

Art. Nr.: 72726 = € 69,00

Art. Nr.: 72727 = DCC € 124,00

Diesellokomotive BR 112, DR / Diesel locomotive class 112, DR



Ep IV

164

NEM 652



Sound

Motor mit Schwungmasse. Antrieb auf vier Achsen, zwei Haftreifen. LED-Spitzenlicht weiß/rot, mit der Fahrtrichtung wechselnd.

Motor with flywheel. Drive on four axles, two of them have traction tyres. White/red LED-lighting that change with the direction of travel.



Art. Nr.: 72857 = € 99,00

Art. Nr.: 72858 = Sound € 174,00



Diesellokomotive BR 202, DB AG / Diesel locomotive class 202, DB AG



Ep V

164

NEM 652



Motor mit Schwungmasse. Antrieb auf vier Achsen, zwei Haftreifen. LED-Spitzenlicht weiß/rot, mit der Fahrtrichtung wechselnd.

- Erstmals als DB AG-Ausführung in orientroter Lackierung.

Motor with flywheel. Drive on four axles, two of them have traction tyres. White/red LED-lighting that change with the direction of travel.

- For the first time with orient red livery.

Art. Nr.: 73755 = € 99,00

Art. Nr.: 73756 = € 174,00

Art. Nr.: 79756 ~ € 174,00

Diesellokomotive 218 220, DB AG / Diesel locomotive 218 220, DB AG



Ep VI

189

PluX22



Motor mit Schwungmasse. Antrieb auf vier Achsen, zwei Haftreifen. LED-Spitzenlicht mit der Fahrtrichtung wechselnd. Fein detailliertes Modell, mit vielen separat angesetzten Teilen.

- Ausführung im aktuellen Betriebszustand des Sylt-Shuttle.
- Passend zu 73721 und 79721 (beides Sonderserien für MC-Vedes).

Motor with flywheel. Drive on four axes. Two traction tyres. LED-lighting that change with the direction of travel. Rich detailing on the model. Model is equipped with digitally switchable sound functions.

- Version in current operating condition of the Sylt-Shuttle.
- Suitable to 73721 and 79721 (A limited edition product produced as a special series exclusively for, and only available from, MC Vedes dealers).



Art. Nr.: 73728 = € 159,00

Art. Nr.: 73729 = € 229,00

Art. Nr.: 79729 ~ € 229,00

Diese aktuellen Sonderanfertigungen 2016 sind nur bei den MC-Vedes Fachhändlern erhältlich. Zu finden unter [www.mc-vedes.de](http://www.mc-vedes.de)

These latest special editions for 2016 are only available from MC-Vedes specialist dealers. They can be found at [www.mc-vedes.de](http://www.mc-vedes.de)

## Elektrolokomotive 110 259, DB / Electric locomotive 110 259, DB



Ep	IV	Art. Nr.: 73578	=	€ 189,99
	190	Art. Nr.: 73579	=	€ 259,99
	PluX22	Art. Nr.: 79579	~	€ 259,99



Elektrolokomotive 110 259-9 der Deutsche Bundesbahn in ozeanblauer/ beiger Farbgebung.

Electric locomotive 110 259-9 of the Deutsche Bundesbahn in ocean blue and beige livery.

## Diesellokomotive 218 175, DB / Diesel locomotive 218 175, DB



Ep	IV	Art. Nr.: 73718	=	€ 249,99
	189	Art. Nr.: 79718	~	€ 249,99
	PluX22			



Diesellokomotive 218 175-8 der Deutschen Bundesbahn.

Diesel locomotive 218 175-8 of the German Federal Railways.

## Diesellokomotive 210 458, DB AG / Diesel locomotive 210 458, DB AG



Ep	V	Art. Nr.: 73717	=	€ 249,99
	189	Art. Nr.: 79717	~	€ 249,99
	PluX22			



Diesellokomotive 210 458-6 der Deutschen Bahn AG.

Diesellokomotive 210 458-6 der of the Deutschen Bahn AG.

## Set 1: „IC Deichgraf“, DB / Set 1: „IC Deichgraf“, DB



Ep	IV
	909
	40196



3-teiliges Wagenset „IC Deichgraf“ der Deutschen Bundesbahn.

3 piece wagon set „IC Deichgraf“ of the German Federal Railways.

Art. Nr.: 64166	=	€ 199,99
-----------------	---	----------

## Set 2: „IC Deichgraf“, DB / Set 2: „IC Deichgraf“, DB



Ep	IV
	922
	40196



3-teiliges Wagenset „IC Deichgraf“ der Deutschen Bundesbahn.

3 piece wagon set „IC Deichgraf“ of the German Federal Railways.

Art. Nr.: 64167	=	n. E.
-----------------	---	-------

## Set 3: „IC Deichgraf“, DB / Set 3: „IC Deichgraf“, DB



2017



Ep	IV
	909
	40196



3-teiliges Wagenset „IC Deichgraf“ der Deutschen Bundesbahn.

2 piece wagon set „IC Deichgraf“ of the German Federal Railways.

Art. Nr.: 64168	=	n. E.
-----------------	---	-------

## Set: Reisezug ALEX / Set: Passenger carriages ALEX



Ep	VI
	909
	40196



3-teiliges Set des Eisenbahn-Verkehrsunternehmens „Alex“.

■ In Zusammenarbeit mit der Firma Tillig.

3 piece set of the Eisenbahn-Verkehrsunternehmens „Alex“.

■ In cooperation with Tillig.

Art. Nr.: 64170	=	€ 199,99
-----------------	---	----------

## Diesellokomotive D 333, RENFE / Diesel locomotive D 333, RENFE

 Sound



Ep  V

238

NEM 652



Motor mit Schwungmasse. Antrieb auf sechs Achsen, zwei Achsen mit Haftreifen. Dreilicht-Spitzenbeleuchtung weiß/rot mit der Fahrtrichtung wechselnd.

Motor with flywheel. Drive on six axles, two of them have traction tyres. Triple headlights (white/red) that change with the direction of travel.

Art. Nr.: 72975 = € 179,00

Art. Nr.: 72976 =  € 249,00

Art. Nr.: 78976 ~  € 249,00

Zubehörkatalog 2015/16  
Accessories Catalogue 2015/16  
Mit Standardmodellen / with standard vehicles

[www.roco.cc](http://www.roco.cc)

-  Lichtanlagen / Lighting
-  geoLine Gleise / geoLine Tracks
-  ROCO LINE Gleise / ROCO LINE Tracks
-  Z21 System / Z21 System
-  Digitale Steuerung / Digital Control
-  Drehscheiben / Turntables
-  Kupplungen / Couplings

## Der Roco Zubehörkatalog 2015/16 The Roco Accessories Catalogue 2015/16

Mit Roco Zubehör immer gut ausgestattet.

Für all jene, die bereits an ihrer eigenen kleinen Miniaturwelt bauen, liegt beim Fachhändler der aktuelle Roco Zubehörkatalog bereit. Darin finden Modellbahner nicht nur unsere digitalen sowie analogen Steuerungssysteme, sondern auch einen Überblick über unser vielfältiges Gleisprogramm und vieles mehr.

Perfectly equipped with Roco accessories.

For all of you who are already building your own miniature world, the new Roco Accessories Catalogue is available from your specialist dealer. The catalogue includes not only our digital and analogue control systems, but also offers an overview of our wide range of tracks and much more.

## Diesellokomotive CC 72000, SNCF / Diesel locomotive CC 72000, SNCF



SNCF

Ep IV

232

PluX22



Art. Nr.: 72986



€ 179,00

Art. Nr.: 72987



€ 269,00

Art. Nr.: 78987



€ 269,00



Sound

Formvariante  
Modified Tooling

Motor mit Schwungmasse, Antrieb auf sechs Achsen, eine Achse mit Haftreifen. LED-Spitzenlicht mit der Fahrtrichtung wechselnd. Viele separat angesetzte Steckteile teilweise als Ätzteil ausgeführt.

- Ausführung mit Spaghetti-Logo.
- Formvariante mit geschlossenem, seitlichen Führerstandsfenster.

Engine with mass flywheel, drive on six axles of which one is equipped with traction tires. LED-lighting that change with the direction of travel. With many separately attached parts that are partially etched.

- Model with Spaghetti-logo.
- Closed cab window variant.

## Dieseltriebzug X2700, SNCF / Diesel multiple unit train X2700, SNCF



SNCF

Ep IV

600

NEM 652



Art. Nr.: 73193



€ 199,00

Art. Nr.: 73194



€ 279,00



Sound

Motor mit Schwungmasse, Antrieb auf zwei Achsen, davon eine mit Haftreifen ausgestattet. Fein detaillierte Ausführung.

- Wiederauflage des beliebten Modells, diesmal auch in Soundausführung.

Motor with flywheel. Drive on two axles, one of them with traction tyre. Rich detailing on the model.

- Reissue of the very popular model - this time available with sound functions.

### Dieseltriebwagen X2800, SNCF / Diesel railcar X2800, SNCF



Ep IV

320

NEM 652



Motor mit Schwungmasse, Antrieb auf zwei Achsen, davon eine mit Haftreifen. Dreilicht-Spitzenbeleuchtung mit der Fahrtrichtung wechselnd.

- Fein detaillierte Ausführung mit durchbrochenen Lüftergittern.
- Vorbildgerechte Inneneinrichtung.
- Passender Beiwagen: Art. Nr. 64541.

Motor with flywheel. Drive on two axles, one of them with traction tyre. Triple headlights that change with the direction of travel.

- Rich ventilation grill detail.
- Interior design true to the original.
- Suitable trailer: Item Nr. 64541.

Art. Nr.: 73190 € 139,00

Art. Nr.: 73191 € 219,00

### Decauville XR, SNCF / Decauville XR, SNCF



Ep IV

244



Passend zu Dieseltriebwagen X2800: Art. Nr. 73190, 73191.

- Vorbildgerechte Inneneinrichtung.

Suitable to Diesel railcar X2800: Item Nr. 73190 and 73191.

- Interior design true to the original.

Art. Nr.: 64541 € 49,90

Beilhack Schneeschleuder, FS / Beilhack Rotary Snow Blower, FS



Ep IV-V

150



A. Di Iorio

Art. Nr.: 72801



€ 399,00



Sound

Formvariante  
Modified Tooling

Modell mit zahlreichen digital schaltbaren Funktionen: Heben und Senken der Fräseinrichtung, drehende Schleuderräder, um 180° drehbarer Aufbau, Beleuchtung mittels LEDs, werkseitig mit Sound ausgestattet.

- Korrekte Wiedergabe der italienischen Ausführung mit vorbildgerechten Formänderungen.

Model with many digitally switchable functions: Lifting and lowering of the snow cutter, rotating blower wheels, entire vehicle platform can be turned 180 degrees, LED-lighting and sound equipment from factory.

- Reissued model of the Italian version with tool modifications to ensure accuracy.

Beilhack Schneeschleuder, NSB / Beilhack Rotary Snow Blower, NSB



Ep VI

150



Modell mit zahlreichen digital schaltbaren Funktionen: Heben und Senken der Fräseinrichtung, drehende Schleuderräder, um 180° drehbarer Aufbau, Beleuchtung mittels LEDs, werkseitig mit Sound ausgestattet.

- Im aktuellen Betriebszustand

Model with many digitally switchable functions: Lifting and lowering of the snow cutter, rotating blower wheels, entire vehicle platform can be turned 180 degrees, LED-lighting and sound equipment from factory.

- In current operating condition

Art. Nr.: 72809



€ 399,00

Art. Nr.: 78809



€ 399,00



Sound



**Diesellokomotive Serie 200/300, NS**  
Diesel locomotive series 200/300, NS



Ep III

83



Art. Nr.: 72795



€ 69,00

Motor mit Schwungrad. Antrieb auf zwei Achsen. In aufwendiger, grüner Lackierung.  
Motor with flywheel. Drive on two axles. In lavishly printed green livery.

**Diesellokomotive Serie 200/300, NS**  
Diesel locomotive series 200/300, NS



Ep IV

83



Art. Nr.: 72796



€ 69,00

Motor mit Schwungrad. Antrieb auf zwei Achsen. In gelb-grauer Lackierung.  
Motor with flywheel. Drive on two axles. In yellow-grey livery.

**Diesellokomotive V100, Locon / Diesel locomotive V100, Locon**



Ep VI

164

NEM 652



Photo: Slg. Modelleisenbahn GmbH

Art. Nr.: 73757



€ 109,00

Art. Nr.: 73758



€ 184,00



Motor mit Schwungrad. Antrieb auf vier Achsen, zwei Haftreifen.  
LED-Spitzenlicht weiß/rot, mit der Fahrtrichtung wechselnd.

Motor with flywheel. Drive on four axles. Two traction tyres. White/red LED-lighting that change with the direction of travel.

Art. Nr.: 79758



€ 184,00

## Diesellokomotive ST44-650, PKP / Diesel locomotive ST44-650, PKP



PKP

Ep IV-V

202

NEM 652



Art. Nr.: 72970



€ 159,00

Art. Nr.: 72971



€ 229,00



Sound



Motor mit Schwungmasse. Antrieb auf sechs Achsen. Zwei Achsen mit Haftreifen. Dreilicht-Spitzenbeleuchtung weiß/rot mit der Fahrtrichtung wechselnd.

- Ausführung mit großen Scheinwerfern, Schalldämpfer und eckigen Puffern.

Motor with flywheel. Drive on six axles, two of them have traction tyres. Triple headlights white/red that change with the direction of travel.

- Version with big beams and yellow contrasting, with silencers and angular buffers.









Ab Frühjahr 2016 erhältlich!  
Available from spring 2016!



Sie sind auf der Suche nach einem persönlichen Geschenk für einen Geburtstag, für ein Jubiläum oder nach einem besonderen Erinnerungsstück? Dann ist „Meine Lok“ von Roco genau das Richtige für Sie!

Wir bieten Ihnen die einzigartige Möglichkeit, eine Elektrolokomotive Rh 1216 „Taurus“ der ÖBB oder eine Elektrolokomotive BR 185.2 der DB AG mit Ihrer ganz individuellen Note zu versehen. Egal, ob es das Vereinslogo sein soll, ein Familienportrait oder eine Zeichnung, die Sie gerne auf Ihrem Modell sehen wollen. Ihr Wunschmodell kann in wenigen Schritten auf [www.roco.cc](http://www.roco.cc) entworfen und bestellt werden\*.

Wir freuen uns schon auf die ersten, kreativen Einsendungen!

Are you looking for that perfect birthday present, something special to celebrate an anniversary, or a very personal memento? Then a personalised Roco locomotive is the right choice!

Have an OBB Rh 1216 Taurus electric locomotive personalised or a DB AG class 185 electric locomotive with the logo of your model railway club, a family portrait or a design you would like to see on your model. A genuinely unique opportunity! It takes just a few steps on [www.roco.cc](http://www.roco.cc) to design and order your personalised model\*.

We look forward to receiving our first creative orders from you!

\*Informationen zu Formaten, bereitzustellenden Daten und Gestaltungsmöglichkeiten finden Sie ab Frühjahr 2016 auf unserer Website [www.roco.cc](http://www.roco.cc).

\*Information on formats, data to be provided and design options will be available on our website at [www.roco.cc](http://www.roco.cc) as from spring 2016.

Elektrolokomotive Rh 1216, ÖBB – Individual / Electric locomotive class 1216, ÖBB – Individual



- Ep VI
- 225
- NEM 652



Sound

Motor mit Schwungmasse. Antrieb auf vier Achsen, zwei Haftreifen. LED-Spitzenlicht weiß/rot mit im Digitalbetrieb schaltbarem Fernlicht und einzeln schaltbarem Spitzen- oder Schlusslicht.

Motor with flywheel. Drive on all four axles, two of them with traction tyres. White/red LED-lighting with digitally switchable high intensity beams. Also equipped with separately switchable headlights and taillights.

- Art. Nr.: 73488 € 269,00
- Art. Nr.: 73489 € 339,00
- Art. Nr.: 79489 € 339,00

Elektrolokomotive BR 185.2, DB AG – Individual / Electric locomotive class 185.2, DB AG – Individual



- Ep VI
- 217
- NEM 652



Motor mit Schwungmasse, Antrieb auf vier Achsen, zwei Haftreifen. LED-Spitzenlicht weiß/rot mit der Fahrtrichtung wechselnd.

Motor with flywheel. Drive on four axles, two of them with traction tyres. White/red LED-lighting that change with the direction of travel.

- Art. Nr.: 73672 € 269,00
- Art. Nr.: 79672 € 309,00

# Kombinieren Sie richtig!

Bilden Sie Züge, wie sie in der Realität auf Schienen unterwegs waren und sind. Mit der Roco Vielfalt kein Problem. Wenn von vorne bis hinten alles stimmt, macht es sogar mehr Freude.

## Create the right combinations!

Reproduce the exact trains which have graced the railways, both past and present. With the wide variety offered by Roco, this should pose no problems. You'll gain more pleasure from knowing that everything is right from the front to the back.

### Abraumzug der ÖBB mit Dampflokk Rh 688 / Freight train of the ÖBB with steam locomotive class 688



Art. Nr.: 72259

Art. Nr.: 67196

### Intercity der ÖBB mit E-Lok Rh 1016 / Eurocity of the ÖBB with electric locomotive class 1016



Art. Nr.: 73230 / 73231 / 79231

Art. Nr.: 45352

Art. Nr.: 45353

Art. Nr.: 45355

Art. Nr.: 45838

Art. Nr.: 64513

### Regionalzug der ÖBB mit E-Lok Rh 4061 / Regional train of the ÖBB with electric locomotive class 4061



Art. Nr.: 73292 / 73293 / 79293

Art. Nr.: 64671

Art. Nr.: 64672

Art. Nr.: 64673

Art. Nr.: 64674

### Güterzug der DB mit Dampflokk 50 2487 / Freight train of the DB with steam locomotive 50 2487



Art. Nr.: 72174 / 72175 / 78175

Art. Nr.: 67109

Art. Nr.: 67109

Art. Nr.: 76250

Art. Nr.: 76250

Güterzug der SBB mit E-Lok Re 482 / Freight train of the SBB with electric locomotive Re 482



Güterzug der DR mit Dampflokk BR 44 / Freight train of the DR with steam locomotive class 44



Schnellzug der DB mit Diesellok BR 210 / Express train of the DB with diesel locomotive class 210



Güterzug der SNCF mit E-Lok BR 186 / Freight train of the SNCF with electric locomotive class 186



Eurocity der SNCB mit E-Lok Reeks 20 / Eurocity of the SNCB with electric locomotive Reeks 20



Personenwagen 1. Klasse, ÖBB / 1st class passenger coach, ÖBB



Art. Nr.: 64671 € 39,90

Personenwagen 1. Klasse der Österreichischen Bundesbahnen.  
1st class passenger coach of the Austrian Federal Railways.

Personenwagen 2. Klasse, ÖBB / 2nd class passenger coach, ÖBB



Art. Nr.: 64672 € 39,90

Personenwagen 2. Klasse der Österreichischen Bundesbahnen.  
2nd class passenger coach of the Austrian Federal Railways.

- Andere Betriebsnummer als 64673.
- Different running number than 64673.

Personenwagen 2. Klasse, ÖBB / 2nd class passenger coach, ÖBB



Art. Nr.: 64673 € 39,90

Personenwagen 2. Klasse der Österreichischen Bundesbahnen.  
2nd class passenger coach of the Austrian Federal Railways.

- Andere Betriebsnummer als 64672.
- Different running number than 64672.

Personenwagen 2. Klasse, ÖBB / 2nd class passenger coach, ÖBB



Art. Nr.: 64674 € 39,90

Personenwagen 2. Klasse mit Gepäckabteil der Österreichischen Bundesbahnen.  
2nd class passenger coach with luggage compartment of the Austrian Federal Railways.

### 1. Klasse Eurofima-Reisezugwagen, ÖBB 1st class, Eurofima coach, ÖBB



Ep VI

303

40196

40360



Art. Nr.: 45352 € € 39,90

Klimatisierter 1. Klasse Abteilwagen Typ Amz. Aktueller Betriebszustand im „Upgrading“-Design mit ÖBB-Wortmarke.

- Einsatz: Schnellzüge, IC, EC
- Wiederauflage mit geänderter Betriebsnummer
- Service: Express trains, IC, EC
- Re-release with altered running number

### 2. Klasse Eurofima-Reisezugwagen, ÖBB 2nd class Eurofima passenger carriage, ÖBB



Ep VI

303

40196

40360



Art. Nr.: 45355 € € 39,90    Art. Nr.: 45838 € € 39,90

Klimatisierter 2. Klasse Abteilwagen Typ Bmz. Aktueller Betriebszustand im „Upgrading“-Design mit ÖBB-Wortmarke.

- Einsatz: Schnellzüge, IC, EC
- Wiederauflage mit geänderter Betriebsnummer
- Service: Express trains, IC, EC
- Re-release with altered running number

### 1./2. Klasse Eurofima-Reisezugwagen, ÖBB 1st/2nd class Eurofima passenger carriage, ÖBB



Ep VI

303

40196

40360



Art. Nr.: 45353 € € 39,90

Klimatisierter 1./2. Klasse Abteilwagen Typ ABmz. Aktueller Betriebszustand. Ausführung im „Upgrading“-Design mit ÖBB-Wortmarke.

- Einsatz: Schnellzüge, IC, EC
- Wiederauflage mit geänderter Betriebsnummer
- Service: Express trains, IC, EC
- Re-release with altered running number

### Modularwagen 2. Klasse, ÖBB 2nd class modular car, ÖBB



Ep VI

303

40196

40420



Art. Nr.: 64513 € € 39,90

Modularwagen 2. Klasse Typ Bmpz in grau/roter Farbgebung mit Helvetica-Beschriftung.

- Einsatz: Schnellzüge, IC, EC
- Service: Express trains, IC, EC

## Schnellzugwagen 1. Klasse, SNCB / 1st class express train wagon, SNCB



Ep V

303

40196

40360



Art. Nr.: 64683

€ 39,90

Eurofima Schnellzugwagen 1. Klasse der Belgischen Staatseisenbahnen.

■ Ausführung im Memling-Design

1st class express train wagon, SNCB

■ Version in Memling-Design

## Schnellzugwagen 2. Klasse, SNCB / 2nd class express train wagon, SNCB



Ep V

303

40196

40360

Eurofima Schnellzugwagen 2. Klasse der Belgischen Staatseisenbahnen.

■ Ausführung im Memling-Design

■ Art. Nr. 64685 mit geänderter Betriebsnummer.

2nd class express train wagon Eurofima of the Belgian State Railways.

■ Version in Memling-Design

■ Item Nr. 64685 with altered running number.

Art. Nr.: 64684

€ 39,90

Art. Nr.: 64685

€ 39,90



## Bahnpostwagen, DB / Post wagon, DB



Ep III

139

40196



Bahnpostwagen der Deutschen Bundespost.

■ Wiederauflage mit geänderter Betriebsnummer

Post wagon of the Deutsche Bundespost.

■ Re-release with altered running number

Art. Nr.: 64417

€ 24,90



### 1. Klasse Schnellzugwagen, DB / 1st class express train wagon, DB



Ep IV

303

40196

40360



Art. Nr.: 64646 € 44,90

Schnellzugwagen 1. Klasse der Deutschen Bundesbahn.  
1st class express train wagon of the German Federal Railways.

### 1./2. Klasse Schnellzugwagen, DB / 1st/2nd class express train wagon, DB



Ep IV

303

40196

40360



Art. Nr.: 64647 € 44,90

Schnellzugwagen 1./2. Klasse der Deutschen Bundesbahn.  
1st/2nd class express train wagon of the German Federal Railways.

### 2. Klasse Schnellzugwagen, DB / 2nd class express train wagon, DB



Ep IV

303

40196

40360



Art. Nr.: 64648 € 44,90

Schnellzugwagen 2. Klasse der Deutschen Bundesbahn.  
2nd class express train wagon of the German Federal Railways.

### Buffetwagen, DB / Buffet car, DB



Ep IV

303

40196

40360



Art. Nr.: 64649 € 44,90

Buffetwagen der Deutschen Bundesbahn.  
Buffet car of the German Federal Railways.

### Gepäckwagen, DB / Luggage wagon, DB



Ep IV

303

40196



Gepäckwagen der Deutschen Bundesbahn.  
Maßstäbliches Modell mit angepasster Inneneinrichtung.

Luggage wagon of the German Federal Railways.  
Scale model with adjusted interior furnishing.

Art. Nr.: 64907 € 54,90

Formneuheit  
New Design

- **Passende Zuglokomotive für die auf dieser Seite abgebildeten Wagen:**  
Diesellokomotive BR 210 der DB, Art. Nr. 73730, 73731 und 79731.
- **Suitable locomotive for the wagons shown on this page:** Diesel locomotive class 210 of the DB, Item Nr. 73730, 73731 and 79731.

## Schnellzugwagen 1. Klasse, DR / 1st class express train wagon, DR



Ep IV

282

40196

40420

Schnellzugwagen 1. Klasse, Bauart Y/B-70 der Deutschen Reichsbahn.

1st class express train wagon type Y/B-70 of the Deutsche Reichsbahn.

Art. Nr.: 64986

€ 39,90



## Schnellzugwagen 1./2. Klasse, DR / 1st/2nd class express train wagon, DR



Ep IV

282

40196

40420



Art. Nr.: 64987

€ 39,90

Schnellzugwagen 1./2. Klasse, Bauart Y/B-70 der Deutschen Reichsbahn.

1st/2nd class express train wagon type Y/B-70 of the Deutsche Reichsbahn.

## Schnellzugwagen 2. Klasse, DR / 2nd class express train wagon, DR



Ep IV

282

40196

40420

Schnellzugwagen 2. Klasse, Bauart Y/B-70 der Deutschen Reichsbahn. Ausführung mit Oberlicht-Klappenfenstern.

2nd class express train wagon type Y/B-70 of the Deutsche Reichsbahn. The model features skylights and hung windows.

Art. Nr.: 64988

€ 39,90



## Schnellzugwagen 2. Klasse, DR / 2nd class express train wagon, DR



Ep IV

282

40196

40420



Art. Nr.: 64991

€ 39,90

Art. Nr.: 64992

€ 39,90

Schnellzugwagen 2. Klasse, Bauart Y/B-70 der Deutschen Reichsbahn.

- Ausführung mit Übersetzfenstern

2nd class express train wagon type Y/B-70 of the Deutsche Reichsbahn.

- Version with sliding windows

## Schnellzugwagen 2. Klasse mit Gepäckabteil, DR 2nd class express train wagon with luggage compartment, DR



Ep IV

282

40196

40420



Art. Nr.: 64989

€ 39,90

Schnellzugwagen 2. Klasse mit Gepäckabteil, Bauart Y/B-70 der Deutschen Reichsbahn.

2nd class express train wagon type Y/B-70 with luggage compartment of the Deutsche Reichsbahn.

## Schnellzug-Liegewagen 2. Klasse, DR 2nd class Couchette coach for express trains, DR



Ep IV

282

40196

40420



Art. Nr.: 64990

€ 39,90

Schnellzug-Liegewagen 2. Klasse, Bauart Y/B-70 der Deutschen Reichsbahn.

2nd class Couchette coach for express trains type Y/B-70 with luggage compartment of the Deutsche Reichsbahn.

## Mitropa-Schlafwagen, DR / Sleeper Mitropa, DR



Ep IV

282

40196

40420



Art. Nr.: 64985

€ 39,90

Mitropa-Schlafwagen, Bauart Y der Deutschen Reichsbahn.

Sleeper Mitropa type Y of the Deutsche Reichsbahn.

Schnellzugwagen 1. Klasse, DB / Luggage wagon, DB



E. A. Weigert

Ep IV-V

303

40196

40420

Art. Nr.: 64916 € 54,90

Schnellzugwagen 1.Klasse, Avnz 108.1 der Deutschen Bundesbahn, in Inter Regio Lackierung. / Luggage wagon of the German Federal Railways, in Inter Regio livery.

Schnellzugwagen 1. Klasse, DB / 1st class express train wagon, DB



E. A. Weigert

Ep IV-V

303

40196

40420

Art. Nr.: 64931 € 54,90

Schnellzugwagen 1.Klasse, Avnz, 108.1 der Deutschen Bundesbahn, in orientroter IC-Lackierung. / 1st class express train wagon Avnz 108.1 of the German Federal Railways in orient-red livery.

2. Klasse Schnellzugwagen, DB / 2nd class express train wagon, DB



E. A. Weigert



Ep IV-V

303

40196

40420

Art. Nr.: 64926 € 54,90

Schnellzugwagen 2. Klasse, Bpmz 294.3 der Deutschen Bundesbahn mit Kinderland Abteil. / 2nd class express train wagon Bpmz 294.3 of the German Federal Railways in Inter Regio-Kinderland livery.

Schnellzugwagen 2. Klasse, DB / 2nd class express train wagon, DB



E. A. Weigert

Ep IV-V

303

40196

40420

Art. Nr.: 64927 € 54,90

Art. Nr.: 64928 € 54,90

- Art. Nr. 64928 mit geänderter Betriebsnummer
- Art. Nr. 64928 with altered running number

Schnellzugwagen 2. Klasse, Bpmz 294.3 der Deutschen Bundesbahn in Inter Regio Lackierung. / 2nd class express train wagon Bpmz 294.3 of the German Federal Railways in Inter Regio-Kinderland livery.

Schnellzugwagen 2. Klasse, DB / 2nd class express train wagon, DB



E. A. Weigert

Ep IV-V

303

40196

40420

Art. Nr.: 64929 € 54,90 Art. Nr.: 64930 € 54,90

Schnellzugwagen 2. Klasse, Bpmz 294.3 der Deutschen Bundesbahn in orientroter IC-Lackierung. / 2nd class express train wagon Bpmz 294.3 of the German Federal Railways in orient-red livery.

Liegewagen „Mond und Sterne“, DSB  
Couchette coach „Moon and stars“, DSB



Ep V

303

40196

40420

Art. Nr.: 64309 € 39,90

Liegewagen „Mond und Sterne“ der Dänischen Staatsbahn.  
Couchette coach „Moon and Stars“ of the Danish State Railways.



### Ostbahn-Schnellzugwagen 1. Klasse, SNCF / 1st class passenger carriage, SNCF



Ep IV

270

40196

40420



Art. Nr.: 64614 € 39,90

Ostbahn-Schnellzugwagen 1. Klasse der Französischen Staatsbahn.

- Einsatz: Nationale und internationale Schnellzüge.

1st class passenger carriage of the French State Railways.

- Service: National and international express trains.

### Ostbahn-Schnellzugwagen 2. Klasse, SNCF / 2nd class passenger carriage, SNCF



Ep IV

270

40196

40420

Ostbahn-Schnellzugwagen 2. Klasse mit Buffetabteil der Französischen Staatsbahn.

- Einsatz: Nationale und internationale Schnellzüge.

2nd class passenger carriage with buffet compartment of the French State Railways.

- Service: National and international express trains.

Art. Nr.: 64615 € 39,90



### Ostbahn-Schnellzugwagen 2. Klasse, SNCF / 2nd class passenger carriage, SNCF



Ep IV

270

40196

40420



Art. Nr.: 64616 € 39,90

Art. Nr.: 64617 € 39,90

Ostbahn-Schnellzugwagen 2. Klasse der der Französischen Staatsbahn.

- Art. Nr. 64617 mit geänderter Betriebsnummer.

- Einsatz: Nationale und internationale Schnellzüge.

2nd class passenger carriage of the French State Railways.

- Item Nr. 64617 with altered running number.

- Service: National and international express trains.

## Personenwagen 1./2. Klasse, FS / 1st/2nd class passenger carriage, FS



Ep III

205

40196

40420

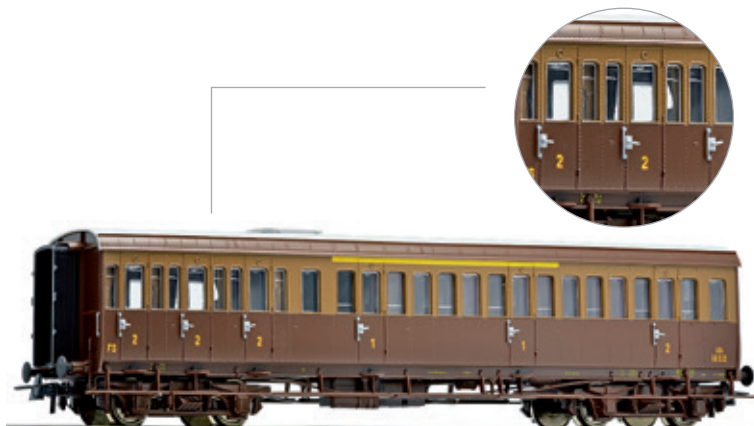

Art. Nr.: 64978

€ 39,90

Reisezugwagen 1./2. Klasse, Serie 66500 „Centoporte“ der Italienischen Staatsbahn.  
1st/2nd class passenger carriage „Centoporte“ series 66500 of the Italian State Railways.

## Personenwagen 2./3. Klasse, FS / 2nd/3rd class passenger carriage, FS



Ep III

205

40196

40420



Art. Nr.: 64979

€ 39,90

Personenwagen 2./3. Klasse, Serie 66500 „Centoporte“ der Italienischen Staatsbahn.  
2nd/3rd class passenger carriage „Centoporte“ series 66500 of the Italian State Railways.

## Personenwagen 3. Klasse, FS / 3rd class passenger coach, FS



Ep III

205

40196

40420



Art. Nr.: 64980

€ 39,90

Art. Nr.: 64981

€ 39,90

Reisezugwagen 3. Klasse, Serie 36000 „Centoporte“ der Italienischen Staatsbahn.

■ Art. Nr. 64981 mit geänderter Betriebsnummer.

3rd class passenger carriage „Centoporte“ series 36000 of the Italian State Railways.

■ Item Nr. 64981 with altered running number.

Set: 2-tlg. Reisezugwagen „Plan D“, NS  
2 piece set passenger carriages „Plan D“, NS

Ep III

544

40196

40420



Art. Nr.: 64151

€ 79,90

2-teiliges Set Reisezugwagen „Plan D“ der Niederländischen Staatsbahn.

■ Passende Ergänzung zu den letztjährig gelieferten Sets Art. Nr. 61449, 61450.

2 piece set passenger carriages „Plan D“ of the Dutch State Railways.

■ Suitable extension for: Item Nr. 61449 and 61450.





Set: 2-tlg. Offene Güterwagen, GKB / 2 piece set gondolas, GKB



PRIVAT

Neukonstruktion  
New Design

Ep III

240

6560



Art. Nr.: 76113

€ 49,90

2-teiliges Set Offene Güterwagen Omm (Bauart Villach) der Graz-Köflacher Bahn, ein Wagen mit Blechbremserhaus. / 2 piece set gondolas type Omm (in the „Villach“ design) of the Graz-Köflacher Bahn. One gondola has a brakeman's cab made of sheet metal.

Set: 2-tlg. Offene Güterwagen, ÖBB / 2 piece set gondolas, ÖBB



Neukonstruktion  
New Design

Ep IV

232

6560



Art. Nr.: 76112

€ 49,90

2-teiliges Set Offene Güterwagen EI 5100 (Bauart Linz) der Österreichischen Bundesbahnen. 2 piece set gondolas type EI 5100 (in the „Linz“ design) of the Austrian Federal Railways



Set: 2-tlg. Offene Güterwagen, SNCB / 2 piece set gondolas, SNCB



Ep III

232

6560



Neukonstruktion  
New Design

Art. Nr.: 76102

€ 49,90

2-teiliges Set Offene Güterwagen Typ 1221 (Bauart Villach) der Belgischen Staatsbahn.  
2 piece set gondolas type 1221 (in the „Villach“ design) of the Belgian State Railways.

Set: 2-tlg. Offene Güterwagen, CSD / 2 piece set gondolas, CSD



CSD

Ep IV

240

6560



Neukonstruktion  
New Design

Art. Nr.: 76103

€ 49,90

2-teiliges Set Offene Güterwagen Vtpr (Bauart Villach) der Tschechoslowakischen Staatsbahnen,  
ein Wagen mit Blechbremserhaus. / 2 piece set gondolas type Vtpr (in the „Villach“ design) of the  
Czechoslovakian State Railways. One gondola has a brakeman's cab.

Set: 2-tlg. Offene Güterwagen, DB / 2 piece set gondolas, DB



Ep III

240

6560



Neukonstruktion  
New Design

Art. Nr.: 76109

€ 49,90

2-teiliges Set Offene Güterwagen Omm 32 (Bauart Linz) der Deutschen Bundesbahn, ein Wagen  
mit Bremserbühne. / 2 piece set gondolas type Omm 32 (in the „Linz“ design) of the German Federal  
Railways. One gondola has a brakeman's platform.

Offener Güterwagen, DB  
Gondola, DB



Ep III

124

6560



Neukonstruktion  
New Design

Art. Nr.: 76250

€ 24,90

Offener Güterwagen Ommr 33 (Bauart Villach) der Deutschen Bundesbahn, Wagen mit Blechbremserhaus.  
/ Gondola type Ommr 33 (in the „Linz“ design) of the German Federal Railways. The gondola has a  
brakeman's cab made of sheet metal.

## Set: 2-tlg. Offene Güterwagen, DR / 2 piece set gondolas, DR

Neukonstruktion  
New Design

Ep IV

232

6560



Art. Nr.: 76108

€ 49,90

2-teiliges Set Offene Güterwagen El-u (Bauart Villach) der Deutschen Reichsbahn (DR Ost).  
2 piece set gondolas type El-u (in the „Villach“ design) of the Deutsche Reichsbahn (DR Ost).

## Set: 2-tlg. Offene Güterwagen, SNCF / 2 piece set gondolas, SNCF

Neukonstruktion  
New Design

Ep IV

232

6560



Art. Nr.: 76111

€ 49,90

2-teiliges Set Offene Güterwagen TTow (Bauart Linz) der Französischen Staatsbahn.  
2 piece set gondolas type TTow (in the „Linz“ design) of the French State Railways.

## Set: 2-tlg. Offene Güterwagen, CFL / 2 piece set gondolas, CFL

Neukonstruktion  
New Design

Ep IV

232

6560



Art. Nr.: 76114

€ 49,90

2-teiliges Set Offene Güterwagen Ttouxwf (Bauart Villach) der Luxemburgischen Staatsbahn.  
2 piece set gondolas type Ttouxwf (in the „Villach“ design) of the Luxembourg National Railway Company.

## Set: 2-tlg. Offene Güterwagen, NS / 2 piece set gondolas, NS

Neukonstruktion  
New Design

Ep III

232

6560



Art. Nr.: 76110

€ 49,90

2-teiliges Set Offene Güterwagen (Bauart Linz) der Niederländischen Staatsbahn.  
2 piece set gondolas (in the „Linz“ design) of the Dutch State Railways.

### Set: 2-tlg. Offene Güterwagen, ÖBB / 2 piece set gondolas, ÖBB



Ep III

264

40196

Art. Nr.: 67196 € 34,90

- Beladen mit Abraummaterial
- Loaded with waste material
- Passende Zuglokomotive: 72259
- Suitable lokomotive: 72259

### Offener Güterwagen, ÖBB / Gondola, ÖBB



Ep IV

161

40183

Art. Nr.: 76967 € 19,90

Offener Güterwagen Bauart Eaos der Österreichischen Bundesbahnen.  
Gondola type Eaos of the Austrian Federal Railways.

### Rungenwagen, ÖBB / Stanchion wagon, ÖBB



Ep IV

229

40196

Art. Nr.: 76767 € 29,90

Rungenwagen Bauart Rs der Österreichischen Bundesbahnen.  
Stanchion wagon type Rs of the Austrian Federal Railways.

### Kesselwagen „OEVA“, ÖBB / Tank wagon „OEVA“, ÖBB



Ep V

179

40196

Art. Nr.: 47359 € 29,90

Kesselwagen „OEVA“ eingestellt bei den Österreichischen Bundesbahnen.  
■ Mit verchromtem Kessel  
Tank wagon „OEVA“ that operates for the Austrian Federal Railways.  
■ With chromed tank

### Doppelwippenwagen, ÖBB / Double tipping goods wagon, ÖBB



Ep V

380

40195

Art. Nr.: 76835 € 59,00

Doppelwippenwagen der Österreichischen Bundesbahnen.  
■ Beladen mit vier Containern der Spedition „delacher + co“.  
Double tipping goods car of the Austrian Federal Railways.  
■ The model carries containers of the forwarding agent „delacher + co“.

Schwenkdachwagen, ÖBB / Swing roof wagon, ÖBB



Ep V-VI

250

40196

Art. Nr.: 67613 € 44,90

Schwenkdachwagen der Österreichischen Bundesbahnen.  
Swing roof wagon of the Austrian Federal Railways.

Set: 3-tlg. Selbstentladewagen, ÖBB  
3 piece set self-unloading hopper wagons, ÖBB



Ep VI

435

40196

Art. Nr.: 67151 € 69,00

3-teiliges Set Selbstentladewagen Bauart Falns der Österreichischen Bundesbahnen.  
3 piece set self-unloading hopper wagons type Falns of the Austrian Federal Railways.

Offener Güterwagen, ÖBB/CD / Gondola, ÖBB/CD



Ep VI

161

40183

Art. Nr.: 76901 € 24,90

Offener Güterwagen der Österreichischen Bundesbahnen.  
■ Beladen mit Echtkohle ■ Mit CD-Logo  
Gondola type Eaos of the Austrian Federal Railways that features CD-logos.  
■ Loaded with real coal ■ With CD-Logo

Schiebeplanenwagen „Steel“, ÖBB  
Sliding tarpaulin wagon „Steel“, ÖBB



Ep VI

138

40196

Art. Nr.: 76440 € 24,90

Schiebeplanenwagen der STEEL-Stahlwaggon AG, einem Tochterunternehmen der Österreichischen Bundesbahnen.  
Sliding tarpaulin wagon of the STEEL-Stahlwaggon AG, a daughter company of the Austrian Federal Railways

Containertragwagen-Doppereinheit, ÖBB / Double container carrier wagon, ÖBB



Ep VI

450

40196

Art. Nr.: 76927 € 89,00

Containertragwagen-Doppereinheit „RCA Mobiler“ der Österreichischen Bundesbahnen. Bauart Sgmmrrss-y.  
Double container carrier wagon unit „RCA Mobiler“ of the Austrian Federal Railways. Type Sgmmrrss-y.



### Schiebeplanenwagen, SNCB / Sliding tarpaulin wagon, SNCB



Ep V-VI

138

40196

Art. Nr.: 67576 € 24,90

Schiebeplanenwagen der B-Cargo, eingestellt bei der Belgischen Staatsbahn. / Sliding tarpaulin wagon of the B-Cargo that operates for the Belgian State Railways.

### Offener Güterwagen mit Container, SNCB Gondola with container, SNCB



Ep VI

161

40183

Art. Nr.: 76904 € 24,90

Offener Güterwagen der Belgischen Staatsbahn, beladen mit einem 40ft. Container Maersk. / Gondola of the Belgian State Railways that carries one 40ft. container of the forwarding agent Maersk.

### Kesselwagen „BP“, SBB / Tank car „BP“, SBB



Ep III

142

40196

Art. Nr.: 76824 € 29,90

Kesselwagen „BP“ eingestellt bei den Schweizerischen Bundesbahnen. / Tank car „BP“ that operates for the Swiss Federal Railways.

### Autotransporter „Goth/GM Suisse“, SBB Stand-in deck coach carrier „Goth/GM Suisse“, SBB



Ep IV

305

40195

Art. Nr.: 66272 € 49,00

Autotransportwagen der Firma Goth, eingestellt bei den Schweizerischen Bundesbahnen. / Private stand-in deck coach carrier of the company Goth that operates for the Swiss Federal Railways.

### Set: Postgüterwagen, SBB / Set of postal goods wagons, SBB



Ep V

336

40196

Art. Nr.: 67184 € 74,00

Art. Nr.: 67185 € 89,00

Art. Nr.: 67186 € 89,00

2-teiliges Set Postgüterwagen Z2 der Schweizerischen Bundesbahnen, in grüner Lackierung mit neuem PTT-Logo.

- Art. Nr. 67185 und 67186: Ausgestattet mit batteriebetriebenen, blinkendem Schlusslicht. Dieses schaltet sich automatisch ein, sobald sich der Wagen in Bewegung setzt und blinkt auch nach Stillstand des Zuges noch mehrere Minuten konstant weiter.

2 piece set postal goods wagons Z2 of the Swiss Federal Railways in green livery with new PTT-Logo.

- Item Nr. 67185 and 67186: equipped with battery-powered, blinking taillight. It turns on automatically when the wagon starts to move and even continues to blink for several minutes after the train has stopped.

## Offener Güterwagen, SBB / Gondola, SBB



Ep VI

161

40196

Art. Nr.: 76902 € 19,90

Offener Güterwagen der Schweizerischen Bundesbahnen.  
Gondola of the Swiss Federal Railways.

Kesselwagen „Uetikon“, SBB  
Tank car „Uetikon“, SBB

Ep V

102

40196

Art. Nr.: 76970 € 26,90

Kesselwagen „Uetikon“ eingestellt bei den Schweizerischen Bundesbahnen.  
Tank car „Uetikon“ that operates for the Swiss Federal Railways.

## Silowagen, SBB / Silo wagon, SBB



Ep V

100

40196

Art. Nr.: 76761 € 27,90

Silowagen Bauart Ucs der Schweizerischen Bundesbahnen, in hellgrauer Ausführung mit schwarzem SBB-Logo. / Silo wagon type Ucs of the Swiss Federal Railways, in light grey livery with black SBB-Logo.

## Silowagen, SBB / Silo wagon, SBB



Ep V

158

40196

Art. Nr.: 76885 € 29,90

Silowagen Bauart Uacs der Schweizerischen Bundesbahnen.  
Silo wagon type Uacs of the Swiss Federal Railways.

## Set: Postgüterwagen, SBB / Set of postal goods wagons, SBB



Ep V-VI

336

40196

Art. Nr.: 67183 € 74,00

2-teiliges Set Postgüterwagen Z2 der Schweizerischen Bundesbahnen.  
2 piece set postal goods wagons Z2 of the Swiss Federal Railways.

## Schiebewandwagen, WASCOSA / Sliding wall wagon, WASCOSA



PRIVAT



Ep VI

161

40183

Art. Nr.: 76793 € 26,90

Schiebewandwagen Bauart Hbillns der WASCOSA.  
Sliding wall wagon type Hbillns of the WASCOSA.

### Rungenwagen, SBB / Stanchion wagon, SBB



Ep VI

229

40183

Art. Nr.: 67582 € 39,90

Rungenwagen Bauart Res der Schweizerischen Bundesbahnen, beladen mit drei 20ft. Containern der Spedition „Evergreen“. / Stanchion wagon type Res of the Swiss Federal Railways that carries three 20ft containers of the forwarding agent „Evergreen“.

### Silowagen „Holcim“, SBB / Silo Wagon „Holcim“, SBB



Ep VI

159

40196

Art. Nr.: 67449 € 29,90

4-achsiger Silowagen „Holcim“ eingestellt bei den Schweizerischen Bundesbahnen.  
4-axle silo wagon „Holcim“ of the Swiss Federal Railways.

### Containerwagen, „ERMEWA“ / Container carrier wagon, „ERMEWA“



PRIVAT



Ep VI

225

40196

Art. Nr.: 76932 € 44,90

Containerwagen der „ERMEWA“, beladen mit drei 20ft. Container Hyundai.  
Container carrier wagon of the forwarding agent „ERMEWA“ that carries three containers of the company Hyundai.

### Einheitstaschenwagen, SBB / Standard pocket wagon, SBB



Ep VI

189

40195

Art. Nr.: 76743 € 39,90

Einheitstaschenwagen der Hupac, beladen mit einem Kühlaufleger „Galliker Foodliner“, eingestellt bei den Schweizerischen Bundesbahnen.  
HUPAC Standard pocket wagon with one refrigerated semitrailer „Galliker“, operated on the Swiss Federal Railways.

### Offener Güterwagen, CD Cargo / Gondola, CD Cargo



Ep VI

161

40183

Art. Nr.: 76899 € 19,90

Offener Güterwagen der Tschechischen Staatsbahn. Geschäftsbereich Cargo.  
Gondola of the Czech State Railways. Division Cargo.

### Schiebeplanenwagen, CD / Sliding tarpaulin wagon, CD



Ep VI

229

40196

Art. Nr.: 76473 € 29,90

Schiebeplanenwagen Bauart Rils der Tschechischen Staatsbahn.  
Sliding tarpaulin wagon type Rils of the Czech State Railways.

## Rungenwagen, DB / Stanchion wagon, DB



Ep III

131

40196

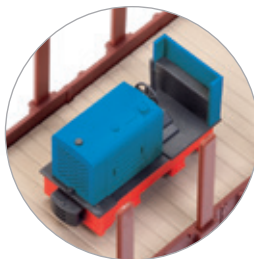

Art. Nr.: 76771 € 29,90

Rungenwagen der Deutschen Bundesbahn mit Feldbahnbeladung.  
Stanchion wagon of the German Federal Railways with light railway cargo.

## Kühlwagen Interfrigo, DB / Refrigerated wagon Interfrigo, DB



Ep III-IV

134

40183



Art. Nr.: 76990 € 22,90

Kühlwagen Interfrigo der Deutschen Bundesbahn.  
Refrigerated wagon Interfrigo of the German Federal Railways.

## Kohlestaubwagen, DR / Coal dust wagon, DR



DR

Ep III

136

40196



Art. Nr.: 66282 € 34,90

Dreiachsiger Staubsilowagen der Deutschen Reichsbahn.  
3-axle bulk freight silo wagon of the German Federal Railways.

## Set: 3-tlg. Erzwagen, DB / 3 piece set ore wagons, DB



Ep IV

342

40183



Art. Nr.: 67148 € 69,00

3-teiliges Set Erzwagen der Deutschen Bundesbahn, beladen mit Erz.  
3 piece set ore wagons of the German Federal Railways, loaded with ore.

## Set: 3-tlg. Offene Güterwagen, DB / 3 piece set gondolas, DB



Ep IV

345

40196



Art. Nr.: 67175 € 49,90

3-teiliges Set Offene Güterwagen der Deutschen Bundesbahn, beladen mit Rüben.  
/ 3 piece set gondolas of the German Federal Railways, loaded with beets.

## Set: 3-tlg. Muldenkippwagen, DB / 3 piece set: dump wagons, DB



Ep IV

309

40196



Art. Nr.: 67129 € 69,00

3-teiliges Set Muldenkippwagen der Deutschen Bundesbahn mit schwarzem Fahrwerk und unterschiedlichen Betriebsnummern.  
/ 3 piece set dump wagons type Fz120 of the German Federal Railways with different running numbers.



**Schwenkdachwagen, „Getreide“, DR**  
**Swing roof wagon „Getreide“ „Grain“, DR**

- 76523 mit geänderter Betriebsnummer
- 76523 with altered running number



Ep IV

219

40196

Art. Nr.: 76522 € 45,90 Art. Nr.: 76523 € 45,90

Schwenkdachwagen „Getreide“ der Deutschen Reichsbahn.  
 Sliding tarpaulin wagon „Grain“ of the Deutsche Reichsbahn.

**Set: 3-tlg. Offene Güterwagen, DR / 3 piece set gondolas, DR**



Ep IV

483

40196

Art. Nr.: 67195 € 69,00

3-teiliges Set Offene Güterwagen der Deutschen Reichsbahn, beladen mit Echtkohle.  
 3 piece set gondolas of the Deutsche Reichsbahn, loaded with real coal.

**Set: 2-tlg. Schwenkdachwagen, DR**  
**2 piece set swing roof wagons, DR**



Ep IV

438

40196

Art. Nr.: 67179 € 89,00

2-teiliges Set Selbstentladewagen „Salz“ der Deutschen Reichsbahn.  
 2 piece set swing roof wagons „Salt“ of the Deutsche Reichsbahn.

**Schwerlastwagen, DB AG / Heavy duty flat wagon, DB AG**



Ep V

187

40196

Art. Nr.: 67574 € 34,90

Schwerlastwagen der Deutschen Bahn AG, beladen mit einer Panzerhaubitze 2000. / Heavy duty flat wagon of the Deutsche Bahn AG. The model carries a tank howitzer 2000.

**Selbstentladewagen, DB AG / Self unloading hopper wagon, DB AG**



Ep V-VI

219

40196

Art. Nr.: 76524 € 45,90

Selbstentladewagen der Deutschen Bahn AG.  
 Self unloading hopper wagon of the Deutsche Bahn AG.

**Offener Güterwagen, DB AG / Gondola, DB AB**



Ep V-VI

161

40183

Art. Nr.: 76965 € 24,90

Offener Güterwagen Bauart Ealos-t der Deutschen Bahn AG.  
 Gondola type Ealos-t of the Deutsche Bahn AG.

**Set: 2-tlg. Schwenkdachwagen, DB AG**  
**2-piece set swing roof wagons, DB AB**



Ep V-VI

438

40196



Art. Nr.: 67178 € 89,00

2-teiliges Set Schwenkdachwagen „SKW Piesteritz“, eingestellt bei der Deutschen Bahn AG. / 2 piece set swing roof wagons „SKW Piesteritz“ that operates for the Deutsche Bahn AG.

**Schiebewandwagen, TRANSWAGGON**  
**Sliding wall wagon, TRANSWAGGON**



PRIVAT

Ep V-VI

276

40196



Art. Nr.: 76481 € 29,90

Schiebewandwagen „TRANSWAGGON“.  
 Sliding tarpaulin wagon „TRANSWAGGON“.

**Autotransportwagen-Einheit, DB SCHENKER**  
**Stand-in deck coach carrier unit, DB SCHENKER**



Ep VI

315

40183



Art. Nr.: 76893 € 59,00    Art. Nr.: 76894 € 59,00

Autotransportwagen-Einheit Bauart Hccrss der DB SCHENKER.  
 ■ Art. Nr. 76894 mit geänderter Betriebsnummer  
 Stand-in deck coach carrier unit type Hccrss of the DB SCHENKER.  
 ■ Item Nr. 76894 with altered running number

**Staubbehälterwagen „KVG“, DB AG / Dust tank car „KVG“, DB AG**



Ep V

219

40196



Art. Nr.: 76701 € 44,90

Staubbehälterwagen „KVG“ der Deutschen Bahn AG.  
 Coal dust container carrier wagon „KVG“ of the Deutsche Bahn AG.

**Set: 2-tlg. Teleskophaubenwagen, RAILLOGIX**  
**2 piece set telescopic hood wagons, RAILLOGIX**



PRIVAT

Ep VI

276

40196



Art. Nr.: 67135 € 48,90

2-teiliges Set Teleskophaubenwagen der RAILLOGIX.  
 2 piece set telescopic hood wagons of the RAILLOGIX.



### Staubbehälterwagen „ERMEWA“ / Dust tank car „ERMEWA“



Ep VI

219

40196

Art. Nr.: 76700 € 44,90

Für den Transport von witterungsempfindlichen, feinkörnigen chemischen Schüttgütern sowie Kohlenstaub. / For the transportation of weather sensitive, fine-granular chemical bulk as well as coal dust.

### Rungenwagen, DSB / Stanchion wagon, DSB



Ep IV

229

40196

Art. Nr.: 76765 € 34,90

Rungenwagen der Dänischen Staatsbahn mit zwei Containern von „LURPAK“. Stanchion wagon of the Danish State Railways that carries a container of the company „LURPAK“.

### Rungenwagen, DSB / Stanchion wagon, DSB



Ep V

162

40196

Art. Nr.: 67436 € 29,90

Schwenkrungenwagen der Dänischen Staatsbahn, beladen mit zwei VW T5-Transportern der DSB. / Flat wagon with swivelling stanchions of the Danish State Railways that carries two VWs T5-transporters of the Danish State Railways.

### Gaskesselwagen „Dansk S.“, DSB / Gas tank wagon „Dansk S.“, DSB



Ep IV

102

40183

Art. Nr.: 67623 € 24,90

Gaskesselwagen „Dansk S.“, eingestellt bei der Dänischen Staatsbahn. Pressurized gas tank wagon „Dansk S.“ that operates for the Danish State Railways.

### Schiebewandwagen, DSB / Sidling wall wagon, DSB



Ep IV

115

40183

Art. Nr.: 76995 € 24,90

Schiebewandwagen der Dänischen Staatsbahn Sliding wall wagon of the Danish State Railways.

- vorbildgerecht mit zwei unterschiedlichen Schiebewänden.
- true to the original with two different sliding doors

### Schiebewandwagen, DSB / Sliding wall wagon, DSB

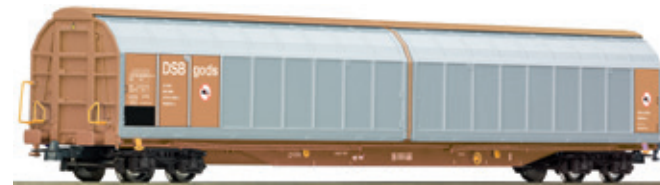

Ep V

267

40196

Art. Nr.: 76480 € 29,90

Schiebewandwagen der Dänischen Staatsbahn. Sliding tarpaulin wagon of the Danish State Railways.

## Der T2000 im Detail

- Filigrane durchbrochene Trittstufen und Gitterbleche
- Variabel bestückbar mit Containern und Auflegern – auch von anderen Herstellern
- Klappriegel für vorbildgerechten Betrieb beiliegend
- Wagen können mit beiliegenden Teilen vorbildgerecht zu einem Schlusswagen umgebaut werden
- Wagen aus Metalldruckguss mit separaten Steckteilen
- Vorbildgerechte Umsetzung der kurzen und langen Ausführung

## The T2000 in detail

- Filigree open worked footboard and steel grids
- Can be assembled optionally with containers and trailers - also from other manufacturers
- Flap bars enclosed for prototypical operation mode
- Cars can be modified to the car running at the rear end of train through enclosed plug-in parts
- Wagon made of metal casting with separate plug-in parts
- Realisation of the short and long version, true to the original

Der T2000 rollt an!  
The T2000 takes off!

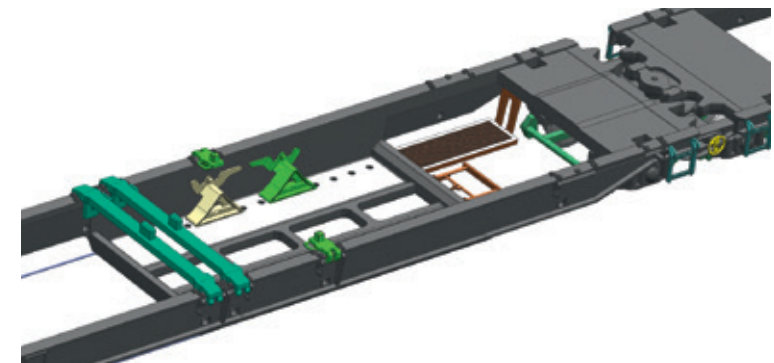
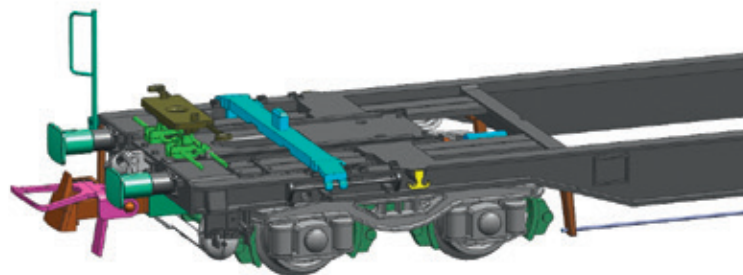
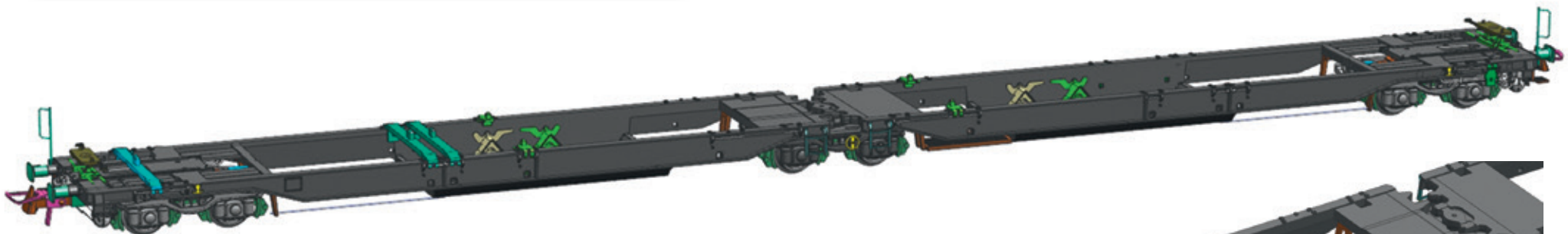
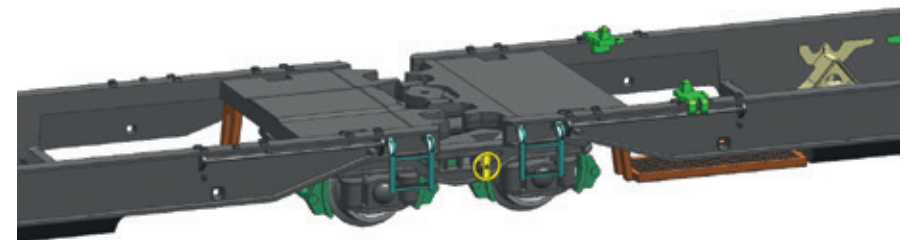
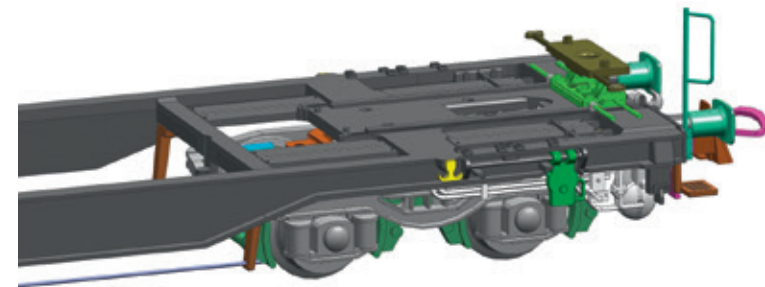

## Doppeltaschen-Gelenkwagen, AAE / DB Cargo Articulated double pocket wagon, AAE /DB Cargo



PRIVAT

Ep V-VI

390

40196



Art. Nr.: 67397 € 89,00

Doppeltaschen-Gelenkwagen der AAE AG mit HANGARTNER-Containern.  
Articulated double pocket wagon of the AAE AG with HANGARTNER-containers.

## Doppeltaschen-Gelenkwagen, AAE Articulated double pocket wagon, AAE



PRIVAT

Ep V-VI

393

40196



Art. Nr.: 67394 € 89,00

Doppeltaschen-Gelenkwagen der AAE AG immatrikuliert bei der DB AG mit paneuropa-Aufliegern. / Articulated double pocket wagon of the AAE AG registered at the DB AG with paneuropa-trailers.

## Doppeltaschen-Gelenkwagen, AAE Articulated double pocket wagon, AAE



PRIVAT

Ep V-VI

390

40196



Art. Nr.: 67392 € 89,00

Doppeltaschen-Gelenkwagen der AAE AG mit Spedition WINNER-Aufliegern.  
Articulated double pocket wagon of the AAE AG with „WINNER Spedition“-trailers.

## Doppeltaschen-Gelenkwagen, AAE Articulated double pocket wagon, AAE



PRIVAT

Ep V- VI

390

40196



Art. Nr.: 67393 € 89,00

Doppeltaschen-Gelenkwagen der AAE AG mit SAE-Aufliegern.  
Articulated double pocket wagon of the AAE AG with SAE-trailers.

## Doppeltaschen-Gelenkwagen, AAE Articulated double pocket wagon, AAE



PRIVAT

Ep V-VI

393

40196



Art. Nr.: 67396 € 89,00

Doppeltaschen-Gelenkwagen der AAE AG mit TERRATRANS-Wechselbrücken.  
Articulated double pocket wagon of the AAE AG with TERRATRANS-swap bodies.

## Doppeltaschen-Gelenkwagen, AAE Articulated double pocket wagon, AAE



PRIVAT

Ep V-VI

393

40196



Art. Nr.: 67395 € 89,00

Doppeltaschen-Gelenkwagen der AAE AG mit paneuropa-Aufliegern.  
Articulated double pocket wagon of the AAE AG with paneuropa-trailers.

# Mit dem T2000 von Nord nach Süd

Come along with the T2000 - from the North to the South



## Doppeltaschen-Gelenkwagen, WASCOSA Articulated double pocket wagon, WASCOSA



PRIVAT

Ep VI

393

40196



Art. Nr.: 67409 € 89,00

Doppeltaschen-Gelenkwagen der WASCOSA mit transped-Aufliegern.  
Articulated double pocket wagon of the WASCOSA with transped-trailers.

## Doppeltaschen-Gelenkwagen, AAE Articulated double pocket wagon, AAE



PRIVAT

Ep VI

393

40196



Art. Nr.: 67408 € 89,00

Doppeltaschen-Gelenkwagen der AAE AG mit arcese-Aufliegern.  
Articulated double pocket wagon of the AAE AG with arcese-trailers.

## Doppeltaschen-Gelenkwagen, WASCOSA Articulated double pocket wagon, WASCOSA



PRIVAT

Ep VI

393

40196



Art. Nr.: 67407 € 89,00

Doppeltaschen-Gelenkwagen der WASCOSA mit GRUBER-Aufliegern.  
Articulated double pocket wagon of the WASCOSA with GRUBER-trailers.

## Doppeltaschen-Gelenkwagen, AAE Articulated double pocket wagon, AAE



PRIVAT

Ep VI

390

40196



Art. Nr.: 67399 € 89,00

Doppeltaschen-Gelenkwagen der AAE AG mit DB SCHENKER-Aufliegern.  
Articulated double pocket wagon of the AAE AG with DB SCHENKER-trailers.

## Doppeltaschen-Gelenkwagen, WASCOSA Articulated double pocket wagon, WASCOSA



PRIVAT

Ep VI

390

40196



Art. Nr.: 67413 € 89,00

Doppeltaschen-Gelenkwagen der WASCOSA mit bring-Aufliegern.  
Articulated double pocket wagon of the WASCOSA with bring-trailers.

## Doppeltaschen-Gelenkwagen, WASCOSA Articulated double pocket wagon, WASCOSA



PRIVAT

Ep VI

390

40196



Art. Nr.: 67412 € 89,00

Doppeltaschen-Gelenkwagen der WASCOSA mit FERCAM-Aufliegern.  
Articulated double pocket wagon of the WASCOSA with FERCAM-trailers.

### Doppeltaschen-Gelenkwagen, AAE

#### Articulated double pocket wagon, AAE



PRIVAT

Ep VI

390

40196



Art. Nr.: 67398 € 89,00

Doppeltaschen-Gelenkwagen der AAE AG mit LKW WALTER-Aufliegern.  
Articulated double pocket wagon of the AAE AG with LKW WALTER-trailers.

### Doppeltaschen-Gelenkwagen, AAE

#### Articulated double pocket wagon, AAE



PRIVAT

Ep VI

393

40196



Art. Nr.: 67406 € 89,00

Doppeltaschen-Gelenkwagen der AAE AG mit TERRATRANS-Aufliegern.  
Articulated double pocket wagon of the AAE AG with TERRATRANS-trailers.

### Doppeltaschen-Gelenkwagen, AAE

#### Articulated double pocket wagon, AAE



PRIVAT

Ep VI

390

40196



Art. Nr.: 67410 € 89,00

Doppeltaschen-Gelenkwagen der AAE AG mit ROTRA- und MAINSPED-Auflieger.  
Articulated double pocket wagon of the AAE AG with ROTRA- and MAINSPED-trailer.

### Doppeltaschen-Gelenkwagen, AAE

#### Articulated double pocket wagon, AAE



PRIVAT

Ep V-VI

390

40196



Art. Nr.: 67385 € 89,00

Doppeltaschen-Gelenkwagen der AAE AG immatrikuliert bei DSB Gods mit coop-Aufliegern. / Articulated double pocket wagon of the AAE AG registered at the DSB Gods with coop-trailers.

### Doppeltaschen-Gelenkwagen, AAE

#### Articulated double pocket wagon, AAE



PRIVAT

Ep V-VI

390

40196



Art. Nr.: 67387 € 89,00

Doppeltaschen-Gelenkwagen der AAE AG immatrikuliert bei DSB Gods mit LAURITZEN-Aufliegern. / Articulated double pocket wagon of the AAE AG registered at the DSB Gods with LAURITZEN-trailers.

### Doppeltaschen-Gelenkwagen, CargoNet

#### Articulated double pocket wagon, CargoNet



PRIVAT

Ep VI

390

40196



Art. Nr.: 67411 € 89,00

Doppeltaschen-Gelenkwagen der CargoNet mit KJELL HANSEN-Aufliegern.  
Articulated double pocket wagon of the CargoNet with KJELL HANSEN-trailers.



### Doppeltaschen-Gelenkwagen, AAE Articulated double pocket wagon, AAE



PRIVAT

Ep V-VI

390

40196



Art. Nr.: 67390 € 89,00

Doppeltaschen-Gelenkwagen der AAE AG vermietet an CargoNet mit BLUE WATER-Aufliegern. / Articulated double pocket wagon of the AAE AG hired out to CargoNet with BLUE WATER-trailers.

### Doppeltaschen-Gelenkwagen, AAE Articulated double pocket wagon T2000, AAE



PRIVAT

Ep V-VI

393

40196



Art. Nr.: 67391 € 89,00

Doppeltaschen-Gelenkwagen der AAE AG vermietet an CargoNet mit DSV-Aufliegern. / Articulated double pocket wagon of the AAE AG hired out to CargoNet with DSV-trailers.

### Doppeltaschen-Gelenkwagen, AAE Articulated double pocket wagon, AAE



PRIVAT

Ep V-VI

393

40196



Art. Nr.: 67386 € 89,00

Doppeltaschen-Gelenkwagen der Green Cargo mit FREJA-Aufliegern. / Articulated double pocket wagon of the Green Cargo with FREJA-trailers.

### Doppeltaschen-Gelenkwagen, WASCOSA Articulated double pocket wagon, WASCOSA



PRIVAT

Ep VI

393

40196



Art. Nr.: 67388 € 89,00

Doppeltaschen-Gelenkwagen der WASCOSA mit bring-Aufliegern. / Articulated double pocket wagon of the WASCOSA with bring-trailers.

### Doppeltaschen-Gelenkwagen, RBSAF Articulated double pocket wagon, RBSAF



PRIVAT

Ep VI

393

40196

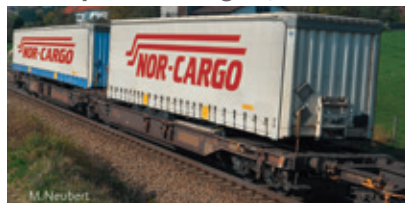

Art. Nr.: 67389 € 89,00

Doppeltaschen-Gelenkwagen der Royal Bank of Scotland mit NOR-CARGO-Aufliegern. / Articulated double pocket wagon T2000 of the Royal Bank of Scotland with NOR-CARGO-trailers.



C. Auerweck

## Schiebewandwagen, RENFE / Sliding wall wagon, RENFE



Ep IV

178

40196



Art. Nr.: 76876 € 24,90

Schiebewandwagen „TRANSFESA“ der Spanischen Staatsbahn.  
Sliding wall wagon „TRANSFESA“ of the Spanish State Railways.

## Schwenkungenwagen, RENFE / Flat wagon with swivel stanchions, RENFE



Ep V

162

40196



Art. Nr.: 76979 € 19,90

Schwenkungenwagen der Spanischen Staatsbahn.  
Flat wagon with swivel stanchions of the Spanish State Railways.

Schiebeplanenwagen, Rail sider  
Sliding tarpaulin wagon, Rail sider

Ep VI

138

40196



Art. Nr.: 67316 € 24,90

Schiebeplanenwagen der Firma Rail sider, eingestellt bei der Spanischen Staatsbahn. / Sliding tarpaulin wagon of the railway company Rail sider, hired out to the Spanish State Railways.

## Rolldachwagen, SNCF / Rolling roof wagon, SNCF



Ep IV

120

40183



Art. Nr.: 76950 € 17,90

Offener Güterwagen mit Rolldach der Französischen Staatsbahn.  
Gondola with rolling roof of the French State Railways.

Autotransportwagen, STVA  
Car carrier, STVA

Ep IV

305

40195



Art. Nr.: 66531 € 44,90

Autotransportwagen der Bauart TA 378 der „Société de Transport de Véhicules Automobiles“ (STVA). / Car carrier of „Société de Transport de Véhicules Automobiles“ (STVA)

## Set: 3-tlg. Knickkesselwagen / 3 piece set: slurry wagons



Ep V

447

40183



Art. Nr.: 67126 € 84,00

3-teiliges Set Knickkesselwagen, eingestellt bei der Französischen Staatsbahn.  
Three piece set slurry wagons, hired out to the French State Railways.

### Schiebeplanenwagen, SNCF / Sliding tarpaulin wagon, SNCF



  
 Ep VI  
 229  
 40196  
 Art. Nr.: 76471 € 29,90

Schiebeplanenwagen der Französischen Staatsbahn.  
Sliding tarpaulin wagon of the French State Railways.

### Schiebeplanenwagen FRET, SNCF / Sliding tarpaulin wagon, FRET



  
 Ep VI  
 138  
 40196  
 Art. Nr.: 76443 € 24,90

Schiebeplanenwagen der Französischen Staatsbahn. Geschäftsbereich FRET.  
Sliding tarpaulin wagon of the French State Railways. Division FRET.

### Containertragwagen, MAV / Container carrier wagon, MAV



  
 Ep V-VI  
 225  
 40196  
 Art. Nr.: 76919 € 44,90

Containertragwagen der Ungarischen Staatsbahn, beladen mit 3 tex-Containern.  
Container carrier wagon of the Hungarian State Railways that carries 3 tex containers.

### Einheitstaschenwagen, FS / Standard pocket wagon, FS



  
 Ep V  
 189  
 40195  
 Art. Nr.: 76740 € 39,90

Einheitstaschenwagen der Italienischen Staatsbahn, beladen mit zwei Containern der Spedition MSC. / Standard pocket wagon of the Italian State Railways that carries containers of the forwarding agent MSC.

### Schwenkdachwagen, FS / Swing roof wagon, FS



  
 Ep V  
 250  
 40196  
 Art. Nr.: 67621 € 44,90

Schwenkdachwagen der Italienischen Staatsbahn.  
Swing roof wagon of the Italian Railways.

### Schwerlastwagen, FS / Heavy duty flat wagon, FS



  
 Ep V  
 187  
 40196  
 Art. Nr.: 67595 € 34,90

Schwerlastwagen der Italienischen Staatsbahn, beladen mit einer Panzerhaubitze 2000. / Heavy duty flat wagon of the Italian State Railways. The model carries a tank howitzer 2000.

Offener Güterwagen, FS / Gondola, FS



Ep V-VI

161

40183

Art. Nr.: 66957 € 24,90

Offener Güterwagen Bauart Eaos-t der Italienischen Staatsbahn zum Transport von Rohholz. / Transport wagon type Eaos-t of the Italian State Railways for the transportation of wood in the rough.

Druckgaskesselwagen, VTG / Pressurized gas tank wagon, VTG



Ep IV-V

183

40196

Art. Nr.: 67607 € 29,90

Druckgaskesselwagen „VTG“, eingestellt bei der Niederländischen Staatsbahn. Pressurized gas tank wagon „VTG“ that operates for the Dutch Railways.

Doppeltragwagen, AAE / Double carrier wagon, AAE



Ep V-VI

390

40196

Art. Nr.: 76929 € 64,00

Doppeltragwagen der Alstätter Eisenbahn AG, beladen mit zwei 40ft. Containern „Richard Kempers“. / Double container carrier wagon of the Alstätter Eisenbahn AG that carries two 40ft containers „Richard Kempers“.

Schotterwagen, railpro / Ballast wagon, railpro



Ep V-VI

111

40195

Art. Nr.: 67599 € 24,90

Schotterwagen Bauart Fccpps der railpro. Ballast wagon type Fccpps of the railpro.

Containertragwagen, AAE / Container carrier wagon, AAE



Ep VI

225

40196

Art. Nr.: 76931 € 44,90

Containertragwagen Bauart Sgns der Ahaus Alstätter Eisenbahn, beladen mit zwei Wechselbrücken „DE WAARD“. / Container carrier wagon type Sgns of the Ahaus Alstätter Eisenbahn, loaded with two swap bodies „DE WAARD“:

Set: 3-tlg. Schotterwagen, railpro / 3 piece set ballast wagon, railpro



Ep VI

333

40196

Art. Nr.: 67156 € 69,90

3-teiliges Set Schotterwagen Bauart Fccpps der railpro. 3 piece set ballast wagon type Fccpps of the railpro.

### Kesselwagen, OnRail / Tank wagon, OnRail



Ep VI

179

40196

Art. Nr.: 67625 € 29,90

4-achsiger Kesselwagen der OnRail.  
4-axle tank wagon of the company OnRail.

### Set: 3-tlg. Kesselwagen, GATX 3 piece set tank wagons, GATX

Ep VI

PRIVAT 537

40196

Art. Nr.: 67136 € 84,00

3-teiliges Set Kesselwagen der GATX.  
3 piece set tank wagons of the GATX.



### Bausatz: Güterzugbegleitwagen, PKP Kit: Caboose, PKP



Ep III

115

40196

Art. Nr.: 76680 € 17,90

Bausatz: Güterzugbegleitwagen der Polnischen Staatsbahn.  
Kit: Caboose of the Polish State Railways.

### Rungenwagen, PKP / Stanchion wagon, PKP



Ep IV-V

229

40196

Art. Nr.: 76981 € 29,90

Rungenwagen Bauart Res der Polnischen Staatsbahn.  
Stanchion wagon type Res of the Polish State Railways.

### Offener Güterwagen, PKP / Gondola, PKP



Ep VI

181

40183

Art. Nr.: 66498 € 19,90

Offener Güterwagen Bauart Eanos der Polnischen Staatsbahn. Geschäftsbereich PKP Cargo. / Gondola type Eanos of the Polish State Railways. Division PKP Cargo.

### Schiebewandwagen, PKP / Sliding wall wagon, PKP



Ep VI

175

40196

Art. Nr.: 76875 € 24,90

Schiebewandwagen der Polnischen Staatsbahn. Geschäftsbereich PKP Cargo.  
Sliding wall wagon of the Polish State Railways. Division PKP Cargo.

Rolldachwagen, ZSSK / Rolling roof wagon, ZSSK



Ep V

161

40183

Art. Nr.: 76945 € 24,90

Rolldachwagen der Slowakischen Staatsbahn.  
Rolling roof wagon of the Slovakian Railways.

Schiebeplanenwagen, ZSSK Cargo  
Sliding tarpaulin wagon, ZSSK Cargo



Ep VI

229

40196

Art. Nr.: 76472 € 29,90

Schiebeplanenwagen der Slowakischen Staatsbahn.  
Sliding tarpaulin wagon of the Slovakian State Railways.

Kesselwagen „GULF“, SJ / Tank wagon „GULF“, SJ



Ep III

102

40183

Art. Nr.: 67593 € 29,90

Kesselwagen „GULF“ eingestellt bei der Schwedischen Staatsbahn.  
Tank wagon „GULF“ hired out to the Swedish State Railway.

Set: 4-tlg. Erzwagen, LKAB / 4 piece set ore wagons, LKAB



- Passende Zuglok: IORE, Art. Nr. 72657, 72658, 78658
- Suitable locomotive: IORE, Item Nr. 72657, 72658, 78658

Ep VI

404

40196



Art. Nr.: 67174 € 119,00

Set bestehend aus vier Erzwagen der Schwedischen Luossavaara-Kiirunavaara Aktiebolag. / The set consists of four ore wagons of the Luossavaara-Kiirunavaara Aktiebolag.

Offener Güterwagen, USATC / Gondola, USATC



USATC

Erstmals im Roco-Programm!  
Available in the Roco product line for the first time!



Ep II-III

96

40179

Art. Nr.: 76830 € 19,90

Offener Güterwagen des United States Army Transportation Corps.  
Gondola of the United States Army Transportation Corps.

Gedeckter Güterwagen, USATC / Boxcar, USATC



USATC

Erstmals im Roco-Programm!  
Available in the Roco product line for the first time!



Ep II-III

96

40179

Art. Nr.: 76842 € 22,90

Gedeckter Güterwagen des United States Army Transportation Corps.  
Boxcar of the United States Army Transportation Corps.

### Flachwagen, USATC / Flat wagon, USATC



USATC

Ep II-III

159

40179



Art. Nr.: 76862

€ 34,90

Flachwagen des United States Army Transportation Corps, beladen mit einem Sherman-Panzer.  
Flat wagon of the United States Army Transportation Corps, loaded with a Sherman tank.

### Flachwagen, USATC / Flat wagon, USATC



USATC

Ep II-III

159

40179



Art. Nr.: 76863

€ 39,90

Flachwagen des United States Army Transportation Corps, beladen mit zwei Halbkettenfahrzeugen.  
Flat wagon of the United States Army Transportation Corps that carries two half track vehicles.

### Set: 2-tlg. Kesselwagen, USATC / 2 piece set: tank cars, USATC



USATC

Ep II-III

286

40179



Art. Nr.: 67117

€ 69,00

2-teiliges Set Kesselwagen des United States Army Transportation Corps.  
2 piece set of tank cars of the United States Army Transportation Corps.





## Das Roco start Programm 2016 The Roco start Program 2016

start

Mit dem Roco start Sortiment auf Schiene.

Alle Neueinsteiger und preisbewussten Modellbahner finden in unserem brandaktuellen start Programm 2016 nicht nur neue Starter Sets sondern auch viele Lokomotiv- und Wagenmodelle zu besonders attraktiven Preisen. Den aktuellen Katalog finden Sie bei Ihrem Fachhändler.

**Get on track with the Roco start Program.**

All newcomers and model railway fans looking for great value, will find new starter sets, numerous locomotives and railcars at very attractive prices in our brand-new start Program 2016. Ask your specialised dealer for the current catalogue





**Elektr locomotive Rh 1099, ÖBB**  
**Electric locomotive class 1099, ÖBB**

Ep IV

125

NEM 651

Art. Nr.: 33255 € 149,00

Motor mit Schwungrad. Antrieb auf sechs Achsen. Dreilicht-Spitzenbeleuchtung, mit der Fahrtrichtung wechselnd.  
 Motor with flywheel. Drive on six axles Triple headlights change with the direction of travel.

**Elektr locomotive 1099 007 „Ötscherbär“, NÖVOG**  
**Electric Locomotive 1099 007 „Ötscherbär“, NÖVOG**

PRIVAT

Ep VI

125

NEM 651

Art. Nr.: 33229 € 149,00

Motor mit Schwungrad. Antrieb auf sechs Achsen. Dreilicht-Spitzenbeleuchtung, mit der Fahrtrichtung wechselnd.  
 Motor with flywheel. Drive on six axles. Triple headlights change with the direction of travel.



- Passende Wagengarnitur: 34030
- Suitable wagon sets: 34030

**Set: 3-tlg. Personenwagen „Ötscherbär“ / 3 piece set „Ötschenbär“**

PRIVAT

Ep VI

465

Art. Nr.: 34030 € 109,00

3-teiliges Set H0e Personenwagen „Ötscherbär“.  
 ■ Passende Zuglokomotive 1099 007 unter Art. Nr. 33229

3 piece set „Ötschenbär“  
 ■ Suitable locomotive 1099 007: Item Nr. 33229



## Gedeckter Güterwagen, ÖBB / Boxcar, ÖBB



Ep IV

128



Art. Nr.: 34536

€ 24,90

Fein detaillierte Ausführung mit Bremserhaus.  
Rich detailing on the model with brakeman's cab.

## Offener Güterwagen, ÖBB / Gondola, ÖBB



Ep IV

128



Art. Nr.: 34537

€ 24,90

Fein detaillierte Ausführung mit Bremserhaus.  
Rich detailing on the model with brakeman's cab.

Set: 3-tlg. Holztransportwagen, ÖBB  
3 piece set wood transport wagons, ÖBB



Ep IV

384



Art. Nr.: 34609

€ 89,00

Fein detaillierte Ausführung, Wagen beladen mit Echtholz.  
Rich detailing on the model, wagons loaded with real wood.

## Gedeckter Güterwagen, DR / open goods wagon, DR



Ep III

128



Art. Nr.: 34529

€ 24,90

Fein detaillierte Ausführung mit Bremserhaus.  
Rich detailing on the model with reinforcement struts.

### Offener Güterwagen, DR / Open goods wagon, DR



Ep III

128

Art. Nr.: 34528

€ 24,90

Fein detaillierte Ausführung mit Bremserhaus.  
Rich detailing on the model with reinforcement struts.

### Rungenwagen, DR / Stake wagon, DR



Ep III

128

Art. Nr.: 34530

€ 24,90

Fein detaillierte Ausführung mit Bremserhaus.  
Rich detailing on the model with reinforcement struts.

### Rollwagen und Güterwagen, DR / Roll wagon and goods wagon, DR



Ep IV

104

Art. Nr.: 34572

€ 44,90

Fein detaillierte Ausführung des Rollwagens mit einem Fahrwerk aus Zinkdruckguss. Kuppelbar mit beiliegender Kuppelstange mit allen H0e Fahrzeugen. Beladen mit einem Güterwagen der Bauart Linz.

Rich detailing on the roll wagon model that features a zinc die-cast chassis. The wagon can be coupled to any kind of H0e vehicles with the attached coupling rod.



## Modellbahnfaszination

Fahren, steuern und verwalten  
in **neuer** Dimension

### Z21 ist ein komplettes Plug & Play System und besteht aus

- der Steuerzentrale
- der Z21 Mobile-App zur Steuerung aller Anlagenkomponenten
- einer laufend erweiterten Anzahl an Führerständen
- dem WLAN Router

Die Digitalzentrale verbindet über WLAN Ihre Modellbahnanlage, digitale Loks und Waggons mit Ihrem Tablet oder Smartphone. Keine Netzwerkkennnisse erforderlich, da WLAN vorkonfiguriert ist.

### Mit Z21 haben Sie ein zukunftssicheres Steuersystem.

Firmware-Upgrades zur weiteren Funktionssteigerung sind einfach zu installieren. Sie haben stets die modernste Funktionalität mit geringem Aufwand.

### Z21 Plug & Play System

- Komplette Anlagen-Steuerung und -Programmierung über WLAN mit Tablet oder Smartphone (für Android und iOS).
- Fotorealistic Führerstände – Bedienmodus nach Wahl: Vom Einsteiger (Beschleunigen, Bremsen bis zum Experten (steuern wie ein echter Lokführer).
- Komplette Bibliothek all Ihrer Loks, Waggons und Anlagenkomponenten mit der Möglichkeit der umfassenden Informationsspeicherung zu Originalen und Modellen.
- Für alle DCC- und Motorola\*-Formate.
- Kompatibel zu LocoNet und Zimo-CAN-Bus, Märklin\*\* und ESU CAN-Bus in Vorbereitung.
- Abwärts kompatibel zu allen multiMaus-Modellen sowie zur Lokmaus 2.
- Integriertes PC-Interface
- Maximale Anschlussmöglichkeiten

## Model Railway Fascination

A whole **new** dimension of driving,  
operating and management

### Z21 is a complete plug & play system consisting of

- the control centre
- the Z21 mobile app for operation of all components
- a continuously growing number of cabins
- the WiFi router

The digital control centre connects your model railway, digital locos and wagons via WiFi to your tablet or smartphone. The WiFi is pre-configured, so no network knowledge required.

### Your Z21 control system is ready for the future.

Firmware upgrades for additional features are simple to install. By this means you will always have the latest functionalities at your fingertips and with a minimum of effort.

### Z21 plug & play system

- Complete set control and programming with tablet or smartphone (for Android and iOS) via WiFi.
- Photorealistic driver's cabins – select your operation mode: from beginner level (accelerating, braking) to expert level (operate your trains like a real locomotive engineer).
- Complete library of all your locos, wagons and system components. You can save comprehensive information on originals and models.
- For all DCC and Motorola\* formats.
- Compatible to LocoNet and Zimo-Can-Bus, Märklin\*\* and ESU CAN-Bus in preparation.
- Downward compatible with all multiMaus models and Lokmaus 2.
- Integrated PC interface
- Maximum connectivity



## WLAN-multiMaus / WiFi-multiMaus



Art. Nr.: 10813

€ 99,00

Handmuster / handmade model

Steuergerät mit vielen Möglichkeiten. Es können mehrere WLAN-multiMäuse gleichzeitig betrieben werden – mit allen Z21 Zentralen möglich.

- Kabellose Freiheit
- Steuerung von bis zu 9999 Loks, 1024 Weichen und Magnetartikeln
- Ergonomische Einhandbedienung für Rechts- und Linkshänder
- Drehregler mit Nullpunktstellung
- Betrieben mit handelsüblichen Batterien oder Akkus (3 x AAA; nicht im Lieferumfang enthalten)
- 64 Lokadressen können in der Datenbank abgelegt und mit Namen versehen werden
- Pro Lok lassen sich bis zu 21 Funktionen (inkl. Stirnbeleuchtung) aktivieren
- Loks können wahlweise mit 14, 28 und 128 Fahrstufen gefahren werden (bei Bedarf für jede Lok änderbar)
- Schreiben und Lesen der CV-Werte Ihrer Lokdecoder
- Display mit einstellbarer Helligkeit

Control unit with many operation functions. Several WiFi-multiMaus can be simultaneously operated – possible with all Z21 systems.

- Wireless freedom
- Control of up to 9999 locomotives, 1024 turnouts and solenoid articles
- Ergonomic one-hand operation for right and left handers
- Controller with center position
- Operated with commercially available standard batteries (3 x AAA, not included in the delivery)
- 64 locomotive addresses can be stored in the database and can be assigned with names
- Up to 21 functions per locomotive can be activated including headlights
- Locomotives can be operated with 14, 28 and 128 speed steps (if necessary this can be changed for each specific locomotive)
- Writing and reading of CV values on your locomotive decoder is possible.
- Display with adjustable brightness

Für WLAN vorbereitet  
Equipped ready to install WiFi

RailCom\*-Fähigkeit  
RailCom\* compatible

**z21 start**

Nur in Starter Sets erhältlich  
Available in Starter Sets only

LESEN und Programmieren erstmals mit der multiMaus möglich. / READING and programming now possible with multiMaus.

Rückseite rear

Einfache und kostengünstige Variante zum schnellen Fahrspaß

Simple, affordable and fast variant for a lot of driving fun

WLAN Erweiterung  
WiFi Upgrade

**z21 WLAN Package  
z21 WiFi Package**

Art. Nr.: 10814 n. E.

Steuern der Züge und Weichen mit Ihrem Smartphone oder Tablet über die bekannte Z21-App\*\*  
Control your trains and turnouts with your SmartPhone or tablet via the popular Z21-App\*\*

Selbsterklärende Steuerfunktionen Ihrer Anlage (durch Icons, Bildeinbindung, etc.) / Self-explanatory control functions for your model railway layout (through icons, image integration, etc.)

Steuern von Lokomotiven mit fotorealistischen Führerständen für das ultimative Fahrerlebnis.  
Control your locomotives with photorealistic driver's cabs for the ultimate driving experience.

Automatisieren von Fahrstraßen / You can automate routes

Setzt den Grundstein für PC geführte Automationen, dank WLAN Schnittstelle (z.B. mit RocoRail®, iTrain®, TrainController®, etc.)  
It lays the basis for PC guided automation, because of WiFi interface (eg. mit RocoRail®, iTrain®, TrainController®, etc.)

\*RailCom ist eine eingetragene Marke von Lenz Elektronik GmbH / \*RailCom is a registered trademark of Lenz Elektronik GmbH  
\*\*Smartphone oder Tablet sind nicht im Package enthalten / \*\*Smartphone or tablet is not included in the package.

### Z21 Booster light / Z21 Booster light



- Stromstärke 3A
- RailCom\*-Lücke (ermöglicht den Einsatz von RailCom\*-Gleisbelegtmelder)
- Kehrschleifenfunktion mittels Kurzschlusserkennung
- Anschluss über B-Bus (auch ideal für mutiZENTRALE<sup>PRO</sup>), ersetzt Booster 10765

Art. Nr.: 10805 € 99,00

- Power 3A
- RailCom\* cutout (allows use of RailCom\*-track occupied detector)
- Terminal loop feature with short-circuit detector
- Connection via B bus (ideal also for mutiZENTRALE<sup>PRO</sup>), replaces Booster 10765

### Z21 Booster / Z21 Booster



- Stromstärke 3A
- Gleisspannung einstellbar (12V-24V)
- RailCom\*-Globaldetektor (ermöglicht POM\*\* - lesen im Boosterabschnitt)
- Kehrschleifenfunktion mittels Kurzschlusserkennung konfigurierbar
- Bremsgeneratorfunktion konfigurierbar
- Anschlüsse über CAN-Bus, B-Bus, CDE-Bus
- Konfiguration und Update einfach per App oder PC

Art. Nr.: 10806 € 149,00

- Power 3A
- Adjustable track voltage (12V-24V)
- RailCom\* global detector (allows POM\*\* reading in the booster section)
- Configurable terminal loop feature with short-circuit detector
- Brake generator feature, configurable
- Connections via CAN bus, B bus, CDE bus
- Configuration and update simply via app or PC

### Z21 Dual Booster / Z21 Dual Booster



Art. Nr.: 10807 € 229,00

- Stromstärke 2x 3A
- Spannung für beide Gleisgänge getrennt über App oder PC einstellbar (12V-24V)
- RailCom\*-Globaldetektor (ermöglicht POM\*\* - lesen im Boosterabschnitt)
- Kehrschleifenfunktion mittels Kurzschlusserkennung getrennt konfigurierbar
- Bremsgenerator für beide getrennt konfigurierbar
- Anschlüsse über CAN-Bus, B-Bus, CDE-Bus
- Konfiguration und Update einfach per App oder PC

- Power 2x 3A
- Voltage can be set for both track outputs separately via app or PC (12V-24V)
- RailCom\* global detector (allows POM\*\* reading in the booster section)
- Terminal loop feature can be separately configured by means of short-circuit detector
- Brake generator feature can separately configured for both
- Connections via CAN bus, B bus, CDE bus
- Configuration and update simply via app or PC

### Z21 Detektor / Z21 Detector



Art. Nr.: 10808 n. E.

- Gleisbelegtmelder für 8 Abschnitte
- Belegtmeldung mittels Stromüberwachung von Gleisabschnitten
- RailCom\*-Melder zur Lokidentifikation
- Anschluss über CAN-Bus und R-Bus
- Konfiguration und Update einfach per App oder PC
- Belegt-/Rückmeldung mit Momentkontakt

- Track-occupied detector for 8 sections
- Occupied message by means of power monitoring of track sections
- RailCom\*-detector for loco identification
- Connection via CAN bus and R bus
- Configuration and update simply via app or PC



## Das Roco TT-Programm 2016

### The Roco TT-Program 2016

Mit dem Roco TT-Programm immer auf der richtigen Spur.

Alle unsere Artikel aus dem TT-Katalog finden Sie ab sofort in unserem eigens gestalteten TT-Programm 2016. Auch darin enthalten ist unsere komplette Neukonstruktion der unter dem Namen „Petroleum P8“ bekannten Diesellokomotive der Baureihe V100 Ost.

**Always on the right track with the Roco TT programme.**

All our articles in the TT range are now available in our specially designed TT programme for 2016, including our completely new design of the V100 Ost class diesel loco known by the name of „Petroleum P8“.



# WAS FINDE ICH WO? / WHERE DO I FIND WHAT?

Art. Nr.	Seite Page	Art. Nr.	Seite Page	Art. Nr.	Seite Page	Art. Nr.	Seite Page	Art. Nr.	Seite Page	Art. Nr.	Seite Page	Art. Nr.	Seite Page	Art. Nr.	Seite Page
10805	102	64168	50	64916	68	67136	93	67398	88	72153	8	72649	37	73191	53
10806	102	64170	50	64926	68	67148	80	67399	87	72158	15	72657	42	73193	52
10807	102	64178	23	64927	68	67151	76	67406	88	72159	15	72658	42	73194	52
10808	102	64179	23	64928	68	67156	92	67407	87	72174	12	72663	39	73202	9
10813	101	64180	23	64929	68	67174	94	67408	87	72175	12	72667	24	73203	9
10814	101	64181	23	64930	68	67175	80	67409	87	72176	13	72668	24	73222	18
33229	97	64182	23	64931	68	67178	82	67410	88	72177	13	72726	48	73223	18
33255	97	64183	23	64978	70	67179	81	67411	88	72194	14	72727	48	73230	20
34030	97	64309	68	64979	70	67183	78	67412	87	72195	14	72795	55	73231	20
34528	99	64417	64	64980	70	67184	77	67413	87	72222	8	72796	55	73232	22
34529	98	64513	63	64981	70	67185	77	67436	83	72223	8	72801	54	73233	22
34530	99	64541	53	64985	67	67186	77	67449	79	72224	13	72809	54	73234	22
34536	98	64614	69	64986	66	67195	81	67574	81	72225	13	72857	48	73235	20
34537	98	64615	69	64987	66	67196	75	67576	77	72230	11	72858	48	73236	20
34572	99	64616	69	64988	66	67316	90	67582	79	72231	11	72879	44	73252	25
34609	98	64617	69	64989	67	67385	88	67593	94	72232	10	72906	44	73253	25
45352	63	64646	65	64990	67	67386	89	67595	91	72233	10	72907	44	73270	27
45353	63	64647	65	64991	67	67387	88	67599	92	72234	10	72948	45	73271	27
45355	63	64648	65	64992	67	67388	89	67607	92	72235	10	72949	45	73272	28
45838	63	64649	65	66272	77	67389	89	67613	76	72259	9	72962	45	73273	28
47359	75	64671	62	66282	80	67390	89	67621	91	72270	7	72963	45	73274	28
62148	14	64672	62	66498	93	67391	89	67623	83	72271	7	72970	56	73275	28
62149	14	64673	62	66531	90	67392	85	67625	93	72278	30	72971	56	73278	25
62197	12	64674	62	66957	92	67393	85	68149	14	72279	30	72975	51	73279	25
62198	12	64683	64	67117	95	67394	85	68198	12	72281	30	72976	51	73280	26
64151	70	64684	64	67126	90	67395	85	72150	15	72282	30	72986	52	73290	17
64166	50	64685	64	67129	80	67396	85	72151	15	72287	30	72987	52	73291	17
64167	50	64907	65	67135	82	67397	85	72152	8	72604	24	73190	53	73292	17



Art. Nr.	Seite Page	Art. Nr.	Seite Page	Art. Nr.	Seite Page	Art. Nr.	Seite Page	Art. Nr.	Seite Page	Art. Nr.	Seite Page		
73293	17	73578	50	73831	40	76767	75	76970	78	79231	20	79598	34
73324	31	73579	50	76102	73	76771	80	76979	90	79233	22	79599	29
73325	31	73597	27	76103	73	76793	78	76981	93	79234	22	79635	35
73328	31	73598	34	76108	74	76824	77	76990	80	79236	20	79639	41
73329	31	73599	29	76109	73	76830	94	76995	83	79253	25	79663	37
73346	38	73635	35	76110	74	76835	75	78151	15	79271	27	79664	37
73347	38	73638	41	76111	74	76842	94	78153	8	79273	28	79666	29
73384	42	73639	41	76112	72	76862	95	78159	15	79275	28	79667	35
73385	42	73663	37	76113	72	76863	95	78175	12	79279	25	79669	39
73392	19	73664	37	76114	74	76875	93	78195	14	79280	26	79672	59
73393	19	73666	29	76250	73	76876	90	78223	8	79291	17	79673	40
73412	32	73667	35	76440	76	76885	78	78231	11	79293	17	79676	39
73434	35	73669	39	76443	91	76893	82	78235	10	79325	31	79717	50
73435	35	73672	59	76471	91	76894	82	78270	7	79329	31	79718	50
73440	41	73673	40	76472	94	76899	79	78271	7	79329	33	79729	49
73441	41	73674	33	76473	79	76901	76	78279	30	79347	38	79731	47
73472	18	73676	39	76480	83	76902	78	78282	30	79385	42	79756	49
73473	18	73717	50	76481	82	76904	77	78287	30	79393	19	79758	55
73482	36	73718	50	76522	81	76919	91	78604	24	79412	32	79831	40
73483	36	73728	49	76523	81	76921	82	78658	42	79435	35		
73488	59	73729	49	76524	81	76927	76	78663	39	79441	41		
73489	59	73730	47	76680	93	76929	92	78668	24	79473	18		
73492	41	73731	47	76700	83	76931	92	78809	54	79482	36		
73493	41	73755	49	76701	82	76932	79	78879	44	79483	36		
73552	19	73756	49	76740	91	76945	94	78907	44	79489	59		
73553	19	73757	55	76743	79	76950	90	78976	51	79553	19		
73567	38	73758	55	76761	78	76965	81	78987	52	79579	50		
73568	38	73830	40	76765	83	76967	75	79223	18	79597	27		

# Impressum / Imprint

## Herausgeber:

Modelleisenbahn München GmbH  
Kronstadter Str. 4, 81677 München, Deutschland  
www.roco.cc

## Preise:

Bei den im Katalog angegebenen Preisen handelt es sich um die zum Zeitpunkt der Drucklegung gültige unverbindliche Preisempfehlung des Herstellers. Wir behalten uns ausdrückliche jederzeitige Preisanpassungen vor. Roco Produkte und Ersatzteile werden über den Modellbahnfachhandel sowie im eigenen e-Shop vertrieben.

## Bildnachweise:

Titel: BR85 (sowie auf Seite 6): Carl Bellingrodt / Eisenbahn Kurier, BR210: D. Kempf  
Modelleisenbahn München GmbH, M. Zirn, S. Zenzmaier, bluforce group, Siemens, Fleischmann-Archiv, Georg Dahlhoff Fotografie sowie bei den Bildern angegebene Fotografen.

Die Anlagenfotos wurden von Heinz Gogg zur Verfügung gestellt. [www.heinzgogg.com](http://www.heinzgogg.com)

Alle Anlagenfotos aus diesem Katalog sind auf der Modellbahnanlage des 1. SMEC Salzburg entstanden. Wir bedanken uns bei allen Clubmitgliedern für ihre Unterstützung.

 [www.smec.at](http://www.smec.at)

## Druck und Verarbeitung:

NP Druck – Druck- und Verlagsgesellschaft m.b.H., Gutenbergstraße 12, 3100 St. Pölten

## Haftung:

Der Katalog ist mit hoher Qualität und Sorgfalt erstellt. Es wird aber keine Haftung für die Richtigkeit sowie Vollständigkeit der Inhalte übernommen. Für eventuelle Schäden materieller oder ideeller Art durch Nutzung, Nichtnutzung oder Vorenthaltung von fehlerhaften oder unvollständigen Informationen in diesem Katalog – soweit sie nicht durch nachweislichen Vorsatz oder nachweisliche grobe Fahrlässigkeit seitens der Modelleisenbahn München GmbH begründet sind – kann keinerlei Gewähr und Haftung übernommen werden. Wir behalten es uns vor, jederzeit die Inhalte des Katalogs sowie die technischen Eigenschaften der darin enthaltenen Produkte zu aktualisieren. Die Wiedergabe von Warenbezeichnungen, Marken, Handelsnamen oder Firmenbezeichnungen und sonstigen Kennzeichen in diesem Produktkatalog berechtigt nicht zu der Annahme, dass diese von jedermann frei benutzt werden dürfen. Vielmehr kann es sich auch dann um eingetragene Marken oder sonstige gesetzlich geschützte Kennzeichen handeln, wenn sie nicht als solche markiert sind.

**Viele Abbildungen zeigen Handmuster. Die endgültige und gelieferte Ausführung der Modelle kann deshalb von den gezeigten Bildern abweichen.**

## Published by:

Modelleisenbahn München GmbH  
Kronstadter Str. 4, 81677 München, Germany  
www.roco.cc

## Price indication:

The prices specified in the catalogue are the manufacturer's suggested retail prices at the time the catalogue went to press. We explicitly reserve the right to make price adjustments at any time. Roco products and spare parts are available through specialized dealers and online at [www.roco.cc](http://www.roco.cc).

The layout photos were made available by Heinz Gogg. [www.heinzgogg.com](http://www.heinzgogg.com)

All layout photos in this catalogue were taken at the model railway system of 1. SMEC Salzburg. We would like to thank all club members for their support.

 [www.smec.at](http://www.smec.at)

## Photo credits:

Title: class 85 (as well as at page 6): Carl Bellingrodt / Eisenbahn Kurier, class 210: D. Kempf  
Modelleisenbahn München GmbH, M. Zirn, S. Zenzmaier, bluforce group, Siemens, Fleischmann-Archiv, Georg Dahlhoff Fotografie as well as other illustrators that are credited next to the pictures.

## Translation by:

eVita Sprachenservice e.U., [eva.unterrainer@aon.at](mailto:eva.unterrainer@aon.at)

## Printing and processing:

NP Druck – Druck- und Verlagsgesellschaft m.b.H., Gutenbergstraße 12, 3100 St. Pölten

## Liability:

We strive to provide the content of this catalogue with the highest quality. Despite of our best effort and the best possible care Roco is not liable and gives no warranty for the accuracy, the up-to-dateness or completeness of the contents and the information given in this catalogue. For eventual damages of material or ideal nature that result from the use, the non-use or the withholding of faulty or incomplete information in this catalogue- as far as it is not founded in demonstrable intent and negligence on part of the Modelleisenbahn München GmbH – no guarantee or liability can be given. We furthermore reserve the right to update the contents of the catalogue as well as the technical specifications of the contained products at any time. The copying of the identifications, trade brands, trade names or company names and other characteristics in this product catalogue does not justify the assumption that those can be used by everybody free of charge. It can rather be that it is a registered trademark or characteristics otherwise protected by law even if these are not specifically marked up as such.

**Many models shown on the illustrations are hand held samples. The final and delivered version of the models may therefore differ from the depicted illustrations.**

## Länderkennung / Country abbreviations

Die Modell-Reihung in diesem Katalog erfolgt innerhalb der Spurweiten H0, H0e und TT nach: Dampflokomotiven, Elektrolokomotiven, Diesellokomotiven, Personenzüge, Güterzüge. Innerhalb der Kategorien erfolgt sie alphabetisch nach den internationalen Kennzeichen.

The ranking of the models within the standards H0, H0e and TT is based: steam locomotives, electric locomotives, diesel locomotives, wagons, freight wagons. Within the categories it is done alphabetically according to the international car license plates.

 <b>Australien (AUS)</b> Australia (AUS)	 <b>Italien (I)</b> Italy (I)
 <b>Belgien (B)</b> Belgium (B)	 <b>Luxemburg (L)</b> Luxembourg (L)
 <b>Schweiz (CH)</b> Switzerland (CH)	 <b>Norwegen (N)</b> Norway (N)
 <b>China (CN)</b> China (CN)	 <b>Niederlande (NL)</b> The Netherlands (NL)
 <b>Tschechische Republik (CZ)</b> Czech Republic (CZ)	 <b>Österreich (A)</b> Austria (A)
 <b>Deutschland (D)</b> Germany (D)	 <b>Polen (PL)</b> Poland (PL)
 <b>Dänemark (DK)</b> Denmark (DK)	 <b>Russland (RUS)</b> Russia (RUS)
 <b>Spanien (E)</b> Spain (E)	 <b>Schweden (S)</b> Sweden (S)
 <b>Frankreich (F)</b> France (F)	 <b>Slowakische Republik (SK)</b> Slovak Republic (SK)
 <b>Ungarn (H)</b> Hungary (H)	 <b>Vereinigte Staaten (USA)</b> United States (USA)
 <b>Hongkong (HK)</b> Hong Kong (HK)	

## Epochenerklärung / Epoch explanation

(Nicht alle kommen in diesem Katalog vor) / (Not all appear in this catalogue)

Ep  I	<b>Epoche / Epoch I:</b> ca. 1870 – 1920
Ep  II	<b>Epoche / Epoch II:</b> ca. 1920 – 1945
Ep  III	<b>Epoche / Epoch III:</b> ca. 1945 – 1968
Ep  IV	<b>Epoche / Epoch IV:</b> ca. 1968 bis 1994
Ep  V	<b>Epoche / Epoch V:</b> 01.1994 bis 2006
Ep  VI	<b>Epoche / Epoch VI:</b> 2007

## Symbole der Bahnverwaltungen / Symbols of railway operators

(Nicht alle kommen in diesem Katalog vor) / (Not all appear in this catalogue)

	<b>Österreichische Bundesbahnen (ÖBB)</b> – nach dem 2. Weltkrieg Austrian Federal Railways (ÖBB) – after World War II
	<b>Nationale Gesellschaft der belgischen Eisenbahnen</b> National Railway Company of Belgium
	<b>Schweizerische Bundesbahnen</b> Swiss Federal Railways
	<b>Lötschbergbahn AG Private Bahngesellschaft</b> Lötschbergbahn AG, Private railway company
	<b>Königl. Preußische Eisenbahn-Verwaltung (K.P.E.V.)</b> Royal Prussian Railway Administration (K.P.E.V.)
	<b>Königliche Bayerische Staatseisenbahn</b> Royal Bavarian State Railways
	<b>Deutsche Reichsbahn (Gesellschaft) (bis 1945) DRG/DRB</b> German Reich Railway Company (up until 1945) DRG/DRB
	<b>Deutsche Reichsbahn (nach 1945) DR</b> German Reich Railway (starting 1945), DR
	<b>Deutsche Reichsbahn (ab etwa 1968)</b> German Reich Railway (approx. since 1968)
	<b>Deutsche Bundesbahn (1951-1993)</b> German Bahn AG (1951-1993)
	<b>Deutsche Bahn AG (seit 1.1.1994)</b> German Bahn AG (since 1.1.1994)
	<b>Dänische Staatsbahnen</b> Danish State Railways
	<b>Spanische Eisenbahn</b> Spanish Railways
	<b>Nationale Gesellschaft der französischen Eisenbahnen</b> National French Railways (SNCF)
	<b>Ungarische Staatsbahnen</b> Hungarian State Railways
	<b>Italienische Staatsbahnen</b> Italian State Railways
	<b>Norwegische Staatsbahnen</b> Norwegian State Railways
	<b>Niederländische Eisenbahnen</b> Dutch Railways
	<b>Polnische Staatsbahnen</b> Polish State Railways
	<b>Schwedische Staatsbahnen</b> Swedish State Railways
	<b>Privates Eisenbahnverkehrsunternehmen</b> Private Railway Companies

## Zeichenerklärung / Legend

(Nicht alle kommen in diesem Katalog vor) / (Not all appear in this catalogue)

	<b>Artikelnummer</b> Article number
	<b>Bahnverwaltung</b> Railway administration
	<b>Epoche</b> Epoch
	<b>Länge über Puffer</b> Overall length
	<b>Gleichstrom</b> Direct current DC
	<b>Gleichstrom mit Sound</b> Direct current DC with sound
	<b>Wechselstrom</b> Alternating current AC
	<b>Wechselstrom mit Sound</b> Alternating current AC with sound
	<b>DCC (Digital ab Werk mit Decoder)</b> DCC (Digital)
	<b>Innenbeleuchtung</b> Interior lighting
	<b>Wechselstrom-Radsatz</b> AC wheel set
	<b>Verdrahtete Decoderverbindung 6 polig</b> 6-pole wire connector for the decoder
	<b>Schnittstelle NEM 651 6 polig</b> 6-pole interface NEM 651
	<b>Schnittstelle NEM 652 8 polig</b> 8-pole interface NEM 652
	<b>Schnittstelle PluX16</b> Interface PluX16
	<b>Schnittstelle PluX22</b> Interface PluX22

# Information aus erster Hand

## First Class Information



### Newsletter

Abonnieren Sie den Roco Newsletter auf [www.roco.cc](http://www.roco.cc) und Sie sind immer informiert. Nur hier erfahren Sie alles über Neuheiten, Exklusivmodelle und Sonderserien.

*Subscribe to the Roco newsletter at [www.roco.cc](http://www.roco.cc) and you are up to date. Only here you will find everything about innovations, exclusive models and special series.*



### Ersatzteile Spare Parts

Wir liefern auch Ersatzteile! Auf [www.roco.cc](http://www.roco.cc) können Sie für Ihre Modelle auch die passenden Ersatzteile bestellen. Der Ersatzteilshop und Ersatzteelfinder hat 24 Stunden am Tag geöffnet und verschickt direkt zu Ihnen nach Hause!

*We also supply spare parts! At [www.roco.cc](http://www.roco.cc) you can order the right spare parts for your models. The spare parts shop and spare parts finder is open 24 hours a day and orders are sent straight to your home.*



### Facebook

Bleiben Sie immer auf dem Laufenden und besuchen Sie uns auf unserer [Facebook-Seite](#). Hier erhalten Sie tägliche Neuigkeiten sowie eine wöchentliche Übersicht der Neuheitenauslieferungen.

*Keep up to date and visit our Facebook site. Enjoy our daily posts about the latest news and the weekly overview of new model releases.*

Ihr Roco-Fachhändler / Your Roco retailer:

80716

Modelleisenbahn München GmbH  
Kronstadter Str. 4  
81677 München • Deutschland | Germany  
[roco@roco.cc](mailto:roco@roco.cc)

